

## Unit 1 - Gas and ARC welding Processes.

Fundamental Principles - Air Acetylene welding, Oxyacetylene welding, Carbon arc welding, Shielded metal arc welding, Submerged arc welding, TIG & MIG welding, Plasma arc welding and Electro slag welding Processes - Advantages, Limitations and applications.

### Fundamental principles of GAS welding

- Gas welding is the process in which a gas flame is used to raise the temperature of the metals to be joined.
- The metals are heated up to melting. The metal flows and on cooling it solidifies.
- A filler metal may be added to the flowing molten metal to fill up cavity made during the end preparation.

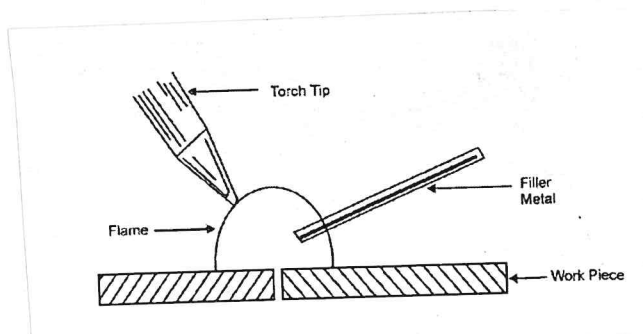

• Many combinations of gases are used in gas welding. But the most common of these is oxygen and acetylene.

### Oxy-acetylene welding

• The process of oxy-acetylene welding can be used for almost all metals and alloys for engineering purposes.

• A high temperature flame ( $3200^{\circ}\text{C}$ ) can be produced by this method. There are two systems of oxygen-acetylene welding.

• High Pressure System: In this process the oxygen and acetylene are taken for use from high pressure cylinders.

• Low Pressure System: In this system oxygen is taken from high pressure cylinder and the acetylene is produced by the action of Calcium carbide and water.



## (a) Principle of Oxy - acetylene Welding

- A very hot flame is produced by burning of the gases coming through the torch tip.
- The edges to be welded are heated up to melting.
- A filler metal is also added to complete the welding. This molten metal mixture when solidifies on cooling forms a welded joint.
- Oxygen cylinder and acetylene cylinder are filled with gases.
- Both the cylinders are attached with pressure gauges, regulators and cylinder valves.
- The cylinder containing oxygen is painted maroon.
- Hase pipes, are provided with each cylinder.
- These pipes are connected to welding torch.

## (b) Welding Process

- To start welding, the acetylene control valve is turned first. When acetylene comes out the nozzle, it should be ignited with spark lighter.

- It will give a yellow-colored smoke flame. After it, oxygen cylinder valve is opened and supply is increased until a most suitable flame is obtained.

- Then the flame is focused on the edges to be welded.

- Flux and filler metal are also added with the heat of flame.

- The edges and filler metal melt and a joint are formed after cooling of the molten metal. The joint may be formed with or without using filler metal.

### (c) Applications.

- Oxy-acetylene welding is particularly used for sheet metal work.

- All the metals can be welded with proper filler metals. Same equipment may be used for cutting purposes.

### (d) Advantages of Oxy-acetylene welding

The main advantages of oxy-acetylene welding are given below:

1. Equipment is cheap as compared to other welding processes.

2. It can be used for welding of all types of metals.

3. Maintenance of equipment is very less.

4. It is a portable process.

5. It can be used for cutting of metals of small thickness.

6. It is specially used for sheet metal work.

### (e) Disadvantages.

1. It takes long time for heating the job as compared to the arc welding.

2. The heat affected area is more

3. This is prone to corrosion and brittleness.

4. Gases are expensive and difficult to store.

### Types of Gas Flames.

There are three types of gas flames.

1. Oxidizing Flame 2. Carburising Flame,

3. Neutral Flame.

a) Oxidizing Flame : When the volume of oxygen gas is more than the volume of acetylene mixed into the torch. This flame is used for welding brass and is also used for cutting the metals.

b) Carburising Flame: When the volume of acetylene mixed is more than oxygen, carburising flame is formed. This flame is used for welding nickel, monel etc.

c) Neutral Flame: It is known as balanced flame. Oxygen and acetylene gases are mixed in equal volumes. Neutral flame is used for normal welding of steel, cast iron etc.

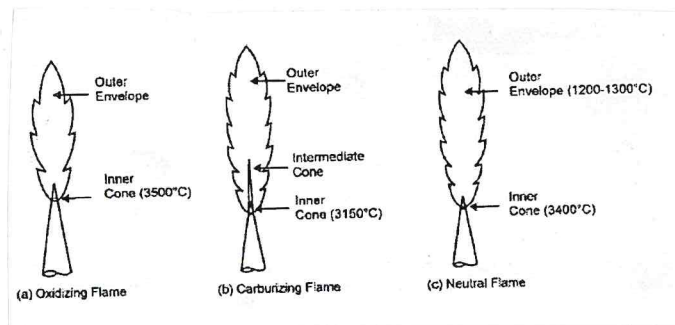

### Gas welding Techniques:

There are two types of gas welding techniques.

#### 1. Left ward welding.

Left ward welding: In this welding the tip of the torch is held at 60 to 70° to the plates. And the filler rod is inclined at 30 to 40° in opposite direction. In this method, the plate edges are heated immediately after the molten metal.

The torch tip and filler rod are moved slowly in the direction towards left. The technique is illustrated in the Fig. 4.

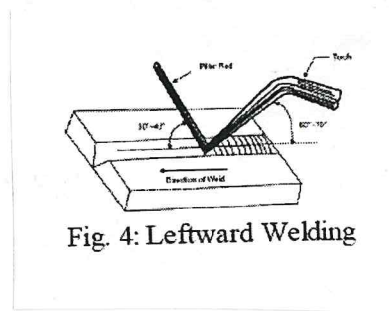

Fig. 4: Leftward Welding

## 2. Right ward welding.

Right ward welding : In right ward welding the torch is kept at 40 to 50° to the job to be welded. Torch is moved towards right as shown in the Fig. 5. Right ward welding is done for heavy sections only.

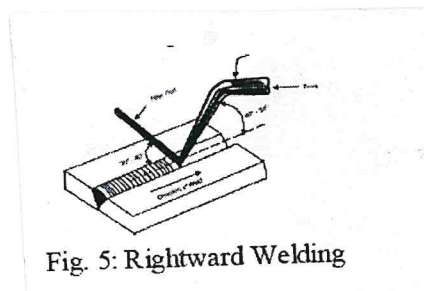

Fig. 5: Rightward Welding

## Flux:

The chemicals which deroxidize the metal surface and provide inert atmosphere around the molten metal are known as fluxes.

The main function of flux is given below:

- To prevent oxides on the hot surfaces.
- To reduce the viscosity of molten metal.
- It maintains a steady arc in case of arc welding. Fluxes are available as liquid, powder, paste and gas.
- Powder flux is sprinkled on the surfaces to be welded or the filler rod is dipped into the powder. Liquid & paste fluxes are sprayed on the surfaces to be welded.
- Gas fluxes are used to form inert atmosphere around the joint to be welded.

Filler:

The rod which provides additional metal in completing the welding is known as filler. The composition of filler metal should be the same as that of the metals to be welded.

Gas welding Equipment:

Details of Gas welding equipment are as under.

Oxygen cylinder:

As shown in Fig. 6. Cylinder is made up of steel in capacity range 2.25 to 6.3 m<sup>3</sup>.



The cylinders are filled with oxygen at about  $150 \text{ kg/cm}^2$  at  $21^\circ\text{C}$ . A safety valve is also provided on it. The cylinder can be opened or closed by a wheel which operates a valve. A protector cap is provided on the top of a cylinder to safeguard the valve.

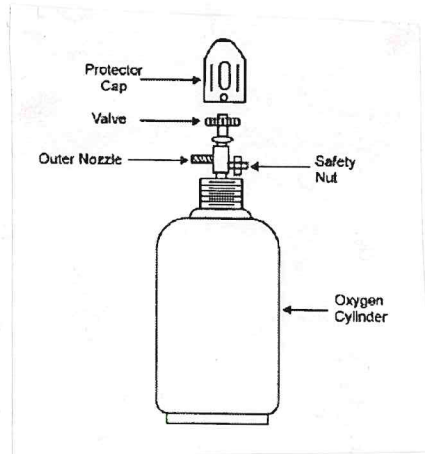

### Acetylene Cylinder :

As shown in Fig:7 Acetylene cylinders are also made up of steel. Gas is filled at a pressure of  $18-20 \text{ kg/cm}^2$ . The capacity of the cylinder is about  $10 \text{ m}^3$ . Regulator valve and safety valve are mounted on cylinder. Safety plugs are also provided on the bottom of the cylinder. When filled into the cylinder, the acetylene is dissolved in acetone.

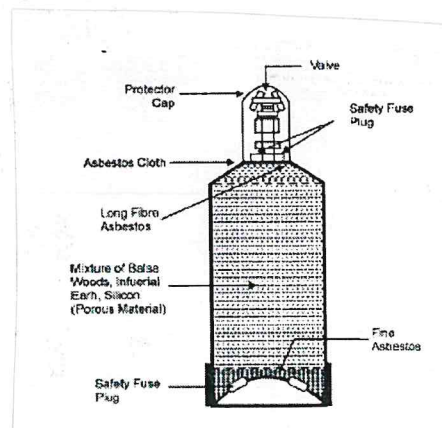

## Regulator:

Regulator is used to control the flow of gases from high pressure cylinders. A simple type of regulator is shown in the Fig. 8.

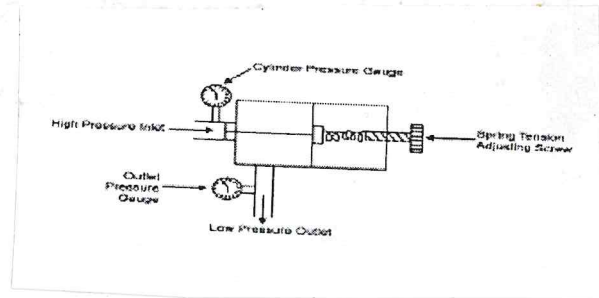

## Torch:

Torch is a device used to mix acetylene and oxygen in the correct proportion and the mixture flows to the tip of the torch. Refer Fig. 9. There are two types of torches.

Low pressure or injector torches.

Medium pressure or equal pressure torches.

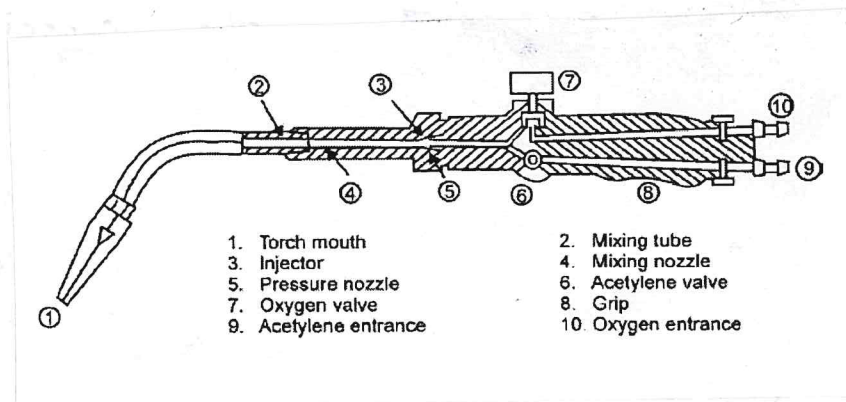

## Low Pressure or Injector Torch:

These torches are designed to use acetylene at low pressure. The pressure is kept very low up to  $0.7 \text{ kg/cm}^2$ . But the oxygen pressure is very high.

## Medium Pressure or equal pressure Torch:

In this type of torch the acetylene is taken at a pressure equal to  $1 \text{ kg/cm}^2$ , the oxygen is always supplied at high pressure. Both types of torches are provided with two needle valves. One regulates the flow of oxygen and the second valve controls the flow of acetylene. A mixing chamber is provided to mix the gases.

## Torch tips:

For different types of jobs, different tips are used. The size of the tip is specified by the outlet hole diameter. More than one hole is also provided in tips. The tip is screwed or fitted on the front end of the torch. Various types of tips are shown in the Fig. 10.

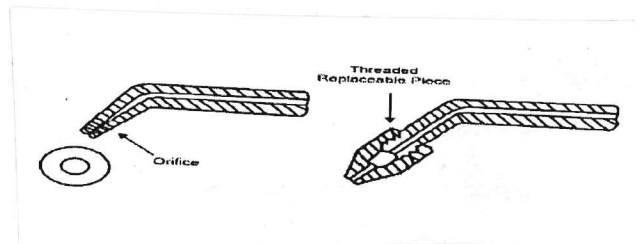

## Goggles:

Gas flames produce high intensity light & heat rays, which are harmful to naked eye. To protect the eyes from these rays, goggles are used. Goggles also protect the eyes from flying sparks.

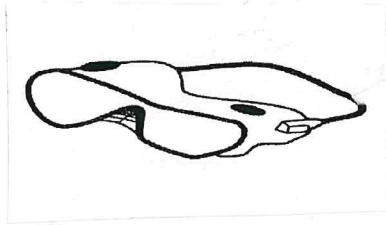

## Lighter:

For starting the flame, the spark should be given by a lighter. Match sticks should not be used, as there is risk of burning hand.

## Fire Extinguishers:

Fire extinguishers are used to prevent the fire that may break out by chance. Sand filled buckets and closed cylinders are kept ready to meet such accidents.

## Difference between High pressure and low Pressure Gas welding.

High pressure welding	Low Pressure welding.
<p>1. Acetylene is available in cylinders</p> <p>2. Pressure is very high in the acetylene cylinder. Minimum pressure is <math>18 \text{ kg/cm}^2</math> pressure regulators are used on both cylinders.</p> <p>3. Oxygen and acetylene gases are mixed in mixing chamber used for heavy work.</p>	<p>1. Acetylene is generated by the action of water and Calcium Carbide.</p> <p>2. Pressure is low. It ranges from <math>0.03</math> to <math>0.14 \text{ kg/cm}^2</math>. No need of pressure regulator on acetylene cylinder.</p> <p>3. Injector is used to mix acetylene with Oxygen used for light work.</p>

## Carbon arc welding:

### Principle

Carbon arc welding (CAW) is a welding process, in which heat is generated by an electric arc struck between a carbon electrode and the work piece. The arc heats and melts the work piece edges, forming a joint.

## Process:

- Carbon arc welding is the oldest welding process.
- If required, filler rod may be used in Carbon Arc welding.
- End of the rod is held in the arc zone.
- The molten rod material is supplied to the weld pool.
- Shields (neutral gas, flux) may be used for weld pool protection depending on type of welded metal.

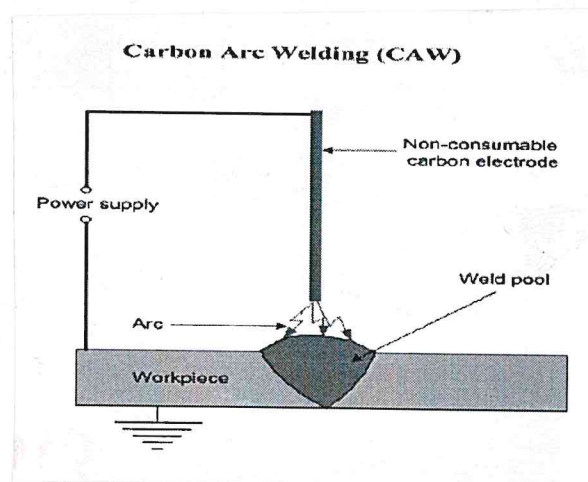

## Types:

1. Single Carbon arc welding
2. Twin Carbon arc welding

• Modification of Carbon Arc Welding is Twin Carbon Electrode Arc welding, utilizing arc struck between two carbon electrodes.

• Work piece is not a part of welding electric circuit in Twin Carbon Electrode Arc welding, therefore the welding torch may be moved from one work piece to other without extinguishing the arc.

### Advantages of Carbon Arc welding.

- Low cost of equipment and welding operation;
- High level of operator skill is not required;
- The process is easily automated;
- Low distortion of work piece.

### Disadvantages of Carbon Arc welding.

- Unstable quality of the weld (porosity);
- Carbon of electrode contaminates weld material with carbides.

### Applications of Carbon Arc welding.

• Carbon Arc Welding has been replaced by Tungsten Inert Gas Arc welding (TIG, GTAW) in many applications.

# Shielded metal arc welding

## Principle.

Shielded metal arc welding (stick welding, Manual metal arc welding) uses a metallic consumable electrode of a proper composition for generating arc between itself and the parent work piece. The molten electrode metal fills the weld gap and joins the work pieces.

## Process:

- This is the most popular welding process capable to produce a great variety of welds.

- The electrodes are coated with a shielding flux of a suitable composition.

- The flux melts together with the electrode metallic core, forming a gas and a slag, shielding the arc and the weld pool.

- The flux cleans the metal surface, supplies some alloying elements to the weld, protects the molten metal from oxidation and stabilizes the arc. The slag is removed after solidification.



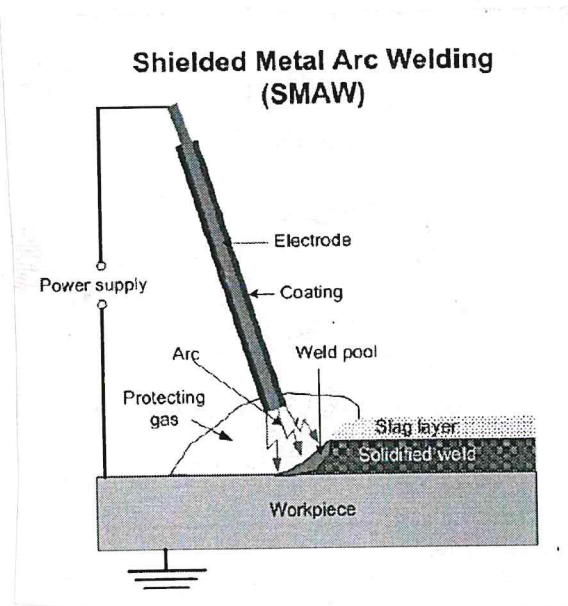

## Advantages of Shielded Metal Arc Welding (SMAW)

- Simple, portable and inexpensive equipment;
- wide variety of metals, welding positions and electrodes are applicable;
- suitable for outdoor applications.

## Disadvantages of Shielded Metal Arc welding (SMAW)

- The process is discontinuous due to limited length of the electrodes;
- weld may contain slag inclusions;
- Fumes make difficult the process control.

## Applications of shielded Metal Arc welding (SMAW)

# Submerged Arc Welding

## Principle

Submerged Arc Welding is a welding process, which utilizes a bare consumable metallic electrode producing an arc between itself and the work piece within a granular shielding flux applied around the weld.

## Process

- The arc heats and melts both the work pieces edges and the electrode wire.
- The molten electrode material is supplied to the surfaces of the welded pieces, fills the weld pool and joins the work pieces.
- Since the electrode is submerged into the flux, the arc is invisible.
- The flux is partially melts and forms a slag protecting the weld pool from oxidation and other atmospheric contaminations.

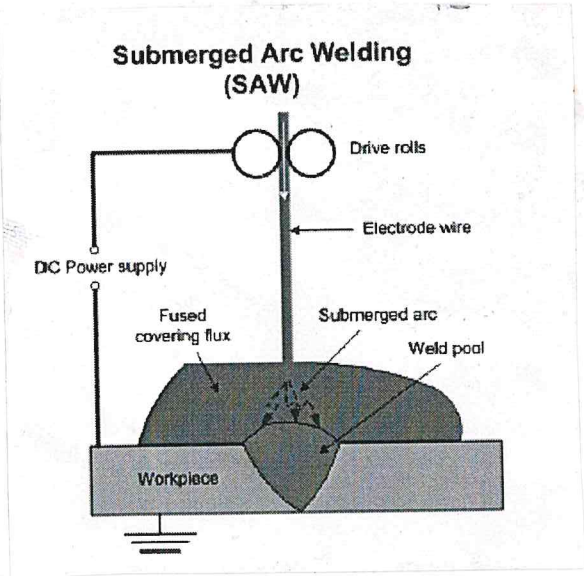

Advantages of submerged Arc Welding (SAW):

- Very high welding rate;
- The process is suitable for automation;
- High quality weld structure.

Disadvantages of Submerged Arc Welding (SAW):

- weld may contain slag inclusions;
- Limited applications of the process - mostly for welding horizontally located plates.

Tungsten Inert Gas Arc Welding (Gas Tungsten Arc welding)

Principle

Tungsten Inert Gas Arc welding [Gas Tungsten Arc welding] is a welding process, in which heat is generated by an electric arc struck between a tungsten non-consumable electrode and the work pieces.

## Process :

- The weld pool is shielded by an inert gas (Argon, helium, Nitrogen) protecting the molten metal from atmospheric contamination.
- The heat produced by the arc melts the work pieces edges and joins them.
- Filler rod may be used, if required.
- Tungsten Inert Gas Arc Welding Produces a high quality weld of most of metals.
- Flux is not used in the process.

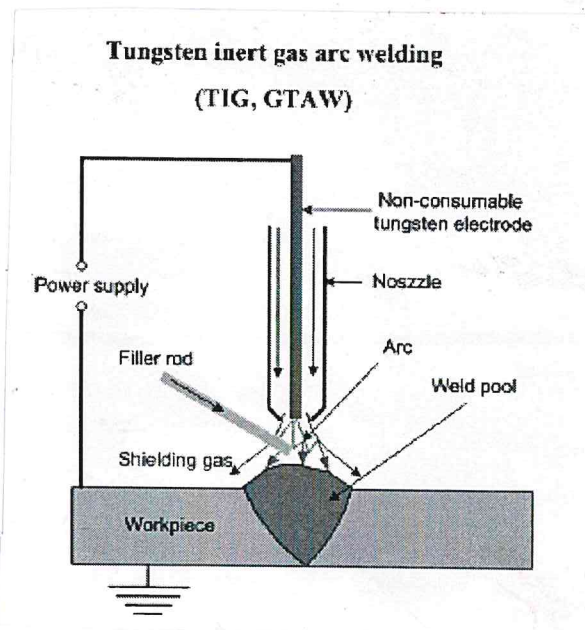

## Advantages of Tungsten Inert Gas Arc Welding

(TIG, GTAW)

- Weld composition is close to that the parent metal;
- High quality weld structures;
- Slag removal is not required (no slag);
- Thermal distortions of work pieces are minimal due to concentration of heat in small zone.

## Disadvantages of Tungsten Inert Gas Arc Welding

(TIG, GTAW)

- Low welding rate;
- Relatively expensive;
- Requires high level of operators skills

## Metal Inert Gas Welding (Gas Metal Arc welding)

### Principle

Metal Inert Gas Welding (Gas Metal Arc welding) is a arc welding process, in which the weld is shielded by an external gas (Argon, helium, CO<sub>2</sub>, argon + oxygen or other gas mixture).

## Process.

- Consumable electrode wire, having chemical composition similar to that of the parent material, is continuously fed from a spool to the arc zone.
- The arc heats and melts both the workpieces edges and the electrode wire.
- The fused electrode material is supplied to the surfaces of the workpieces, fills the weld pool and forms joint.
- Due to automatic feeding of the filling wire (electrode) the process is referred to as a semi-automatic.
- The operator controls only the torch positioning and speed.

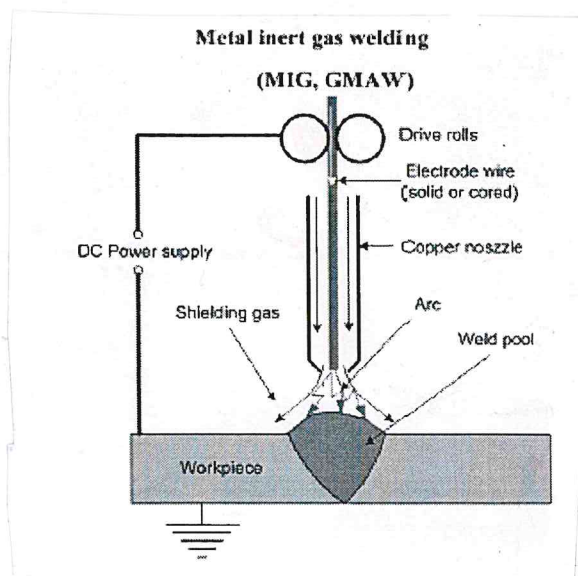

## Advantages of Metal Inert Gas welding (MIG, GMAW)

- Continuous weld may be produced (no interruptions.);
- High level of operators skill is not required;
- Slag removal is not required (no slag)

## Disadvantages of Metal Inert Gas welding (MIG, GMAW)

- Expensive and non-portable equipment is required;
- outdoor applications are limited because of effect of wind, dispersing the shielding gas.

Plasma Arc welding is the welding process.

### Principle.

plasma Arc welding is the welding process utilizing heat generated by a constricted arc struck between a tungsten non-consumable electrode and either the work piece (transferred arc process) or water cooled constricting nozzle (non-transferred arc process).

## Process:

- Plasma is a gaseous mixture of positive ions, electrons and neutrals gas molecules;
- Transferred arc process produces plasma jet of high energy density and may be used for high speed welding and cutting of Ceramics, Steels, Aluminum alloys, Copper alloys, Titanium alloys, Nickel alloys, Non-transferred arc process plasma of relatively low energy density;
- It is used for welding of various metals and for plasma spraying (coating);
- Since the work piece in non-transferred plasma arc welding is not a part of electric circuit, the plasma arc torch may move from one work piece to other without extinguishing the arc.

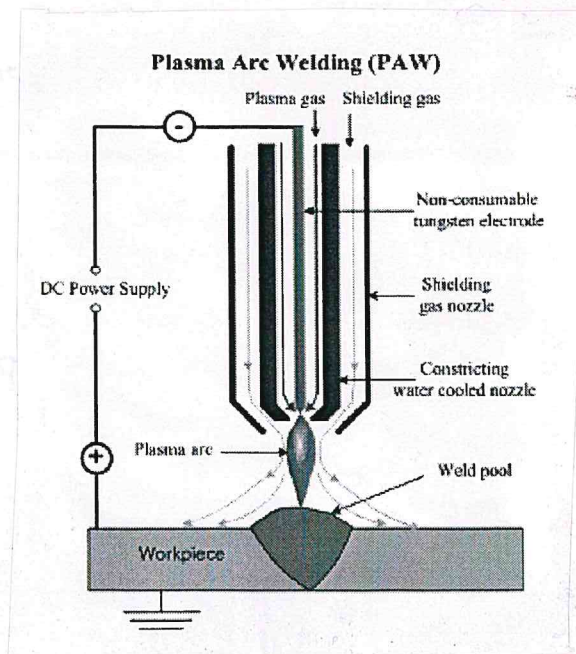



## Advantages of Plasma Arc Welding (PAW)

- Requires less operator skill due to good tolerance of arc to misalignments;
- High welding rate;
- High penetrating capability (keyhole effect).

## Disadvantages of Plasma Arc Welding (PAW)

- Expensive equipment;
- High distortions and wide welds as a result of high heat input (in transferred arc process).

## Electroslag Welding

### Principle.

Electroslag welding is a welding process, in which the heat is generated by an electric current passing between the consumable electrode (filler metal) and the work piece through a molten slag covering the weld surface.

### Process:

- Prior to welding the gap between the two work pieces is filled with a welding flux.
- Electroslag welding is initiated by an arc between the electrode and the work piece (or starting plate).

- Heat, generated by the arc, melts the fluxing powder and forms molten slag.

- The slag, having low electric conductivity, is maintained in liquid state due to heat produced by the electric current.

- The slag reaches a temperature of about  $3500^{\circ}\text{F}$  ( $1930^{\circ}\text{C}$ ). This temperature is sufficient for melting the consumable electrode and work piece edges.

- Metal droplets fall to the weld pool and join the work pieces. Electroslag welding is used mainly for steels.

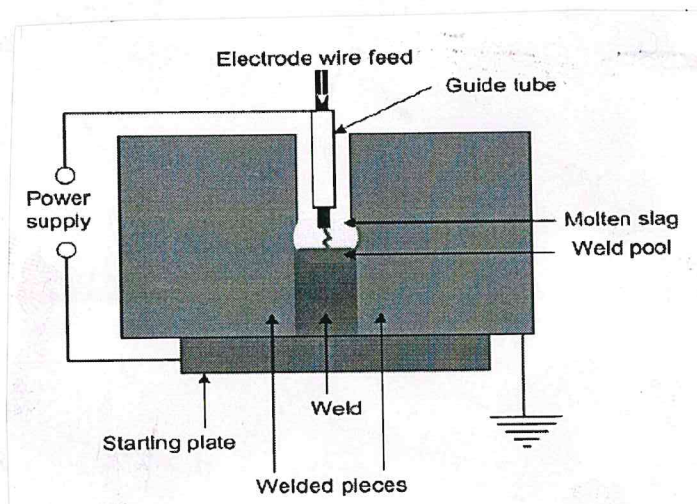

## Advantages of Electro slag welding.

- High deposition rate - up to 45 lbs/h (20 kg/h);
- Low slag consumption (about 5% of the deposited metal weight);
- Low distortion;
- Unlimited thickness of work piece.

## Disadvantages of Electro slag welding.

- Coarse grain structure of the weld;
- Low toughness of the weld;
- Only vertical position is possible.

At the end of the day, the...

...the ... of the ...

...the ... of the ...

...the ... of the ...

...the ... of the ...

...the ... of the ...

...the ... of the ...

## Unit-II - Resistance Welding Processes.

Spot welding, Seam welding, Projection welding, Resistance Butt welding, Flash Butt welding, Percussion welding and High frequency resistance welding Process - advantages, limitations and application.

### Resistance Welding.

- Resistance welding is a thermo-electric process where heat is generated at the interface of the parts to be joined by passing an electrical current through them for a precisely controlled time and under a controlled pressure (also called force).

- The name "resistance" spot welding derives from the fact that the resistance of the workpieces and electrodes are used in combination or contrast to generate the heat at their interface.

## Advantages:

1. Less skill is required to operate the resistance welding machine.
2. This type of welding is well suited for mass production as it gives a high production rate.
3. There is no need of using consumables such as brazing materials, solder or welding rods in this process except for the electrical power and a relatively smaller electrode wear.
4. Heating the work pieces is confined to a very small part which results less distortion.
5. It is possible to weld dissimilar metals as well as metal plates of different thickness.
6. It has a short process time.
7. It offers more safety to operate because of low voltage.
8. It produces clean and environmentally friendly weld.
9. A reliable electro-mechanical joint is formed.
10. The heat is localized, action is rapid and no filler metal is required.

11. The operation can be easily mechanized and automated due to the need of less skill.

12. Both reliability and reproducibility can be obtained with high degree.

13. The welding process is more economical.

### Limitations:

1. The resistance welding machine is highly complex with various elements such as heavy transformer, electrodes and heavy conductors for carrying the high current electrode force applying mechanism such as a pneumatic cylinder and its supply heavy machine structure to support the large forces and an expensive timeline arrangement.

2. Certain resistance welding processes are limited only to lap joints.

3. Spot welds have low tensile and fatigue strength.

4. Equipment is not portable as it is heavy.

5. The cost of equipment is high.

## Applications:

1. Resistance welding is used in mass production for welding sheet metal, wire tubes.
2. It is used in welding bars, boxes, cans, rods, pipes and frames metals of medium and high resistance materials such as steel, stainless steel, monel metal and silica bronze which are easy to weld.
3. Is used in welding aircraft and automobile parts.
4. It is used for making cutting tools.
5. It is used for making fuel tanks of cars, tractors etc.
6. It is used for making wire fabrics, grids, grills, mesh weld, containers etc.

## Spot welding.

● It is one type of electrical resistance welding processes. Spot welding is used for making lap joints.

● By using this method, the metal sheets ranging from 0.025 mm to 1.25 mm thickness can be easily welded.



- The metal pieces are assembled and placed between two copper electrodes and then current is passed.

- The parts are heated at their area of contact by electrical resistance as shown in Fig. 2.2.

- Then the electrodes are pressed against the metal pieces by mechanical or hydraulic pressure as shown in Fig. 2.3.

### Principle.

Spot welding is "the welding of overlapping pieces of metal at small points by application of pressure and electric current."

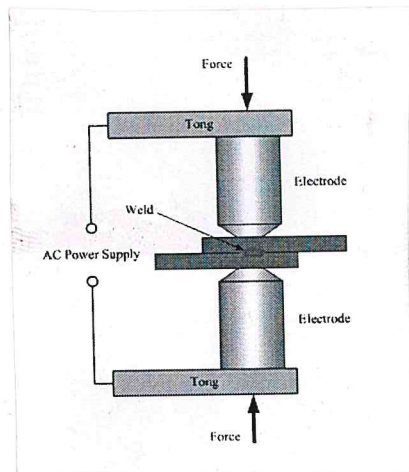

### Process:

- The electrodes must possess high electrical and thermal conductivity and they retain the strength at high temperature.

- So, they are made of pure copper for a limited amount of service and alloys of Copper or tungsten or molybdenum alloys for extended service life.

- The electrode pressure can be in the range of up to 2KN. Electrodes are cooled by water during the operation to prevent overheating.

- Electrodes seated in a weld head are brought to the surface of the parts to be joined and force (pressure) is applied.

- Current is applied through the electrode to the workpiece to melt the material.

- Current is removed but electrodes remain in place at force to allow the material to cool and solidify.

- The method uses pointed copper electrodes providing passage of electric current. The electrodes also transmit pressure required for formation of strong weld.

- Diameter of the weld spot is in the range  $\frac{1}{8}'' - \frac{1}{2}''$  (3-12mm).

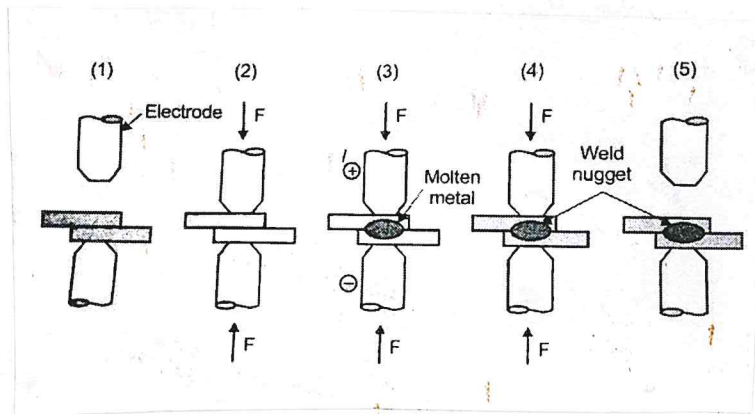

### Advantages:

1. Spot welding is quick and easy,
2. There is no need to use any fluxes or filler metal to create a joint by spot welding and there is no dangerous open flame.
3. Spot welding can be performed without any special skill.
4. Automated machines can spot weld in factories to speed up production.
5. The rate of production is high.
6. Spot welding can be used to join many different metals and it can join different types to each other.

7. Sheets as thin as  $\frac{1}{4}$  inch can be spot welded and multiple sheets may be joined together at the same time.

8. The procedure involves less amount maintenance cost.

9. Ability of the worker does not influence the quality of spot welds obtained by this procedure.

10. The process is usually free from burn and splash.

11. Spot welding is more economical.

12. No edge preparation is required.

13. Small heat affected zone is produced.

14. It eliminates warping and distortion of parts.

### Limitations:

1. It can create only localized joints which may not be particularly strong.

2. The electrodes have to be able to reach both sides of the pieces of metal that being joined together.

3. Warping and a loss of fatigue

Strength can occur around the point where the metal has been spot welded.

4. It is suitable for thin sheets only.

5. Equipment used in spot welding is costly.

### Applications :

1. It is used in joining killed carbon steel, low alloy steel, high alloy steel, etc.

2. It is frequently used in the creation of auto body components with a role moving the spot welding device about the stationary auto frame. Typical car body has about 10,000 spot welds.

3. It is widely used in mass production of automobiles, appliances, metal furniture and other products made of steel metal.

4. It is used in manufacture of sheet metal goods.

5. It is used in assembling sheet metal to steel structures.

6. It is used in making cookware and muffers.

7. Other applications include appliances and metal furniture i.e. virtually anything involving the joining of sheet metal.

Seam welding or Resistance seam welding (RSW)

### Principle.

- Seam welding is a variation of resistance spot welding.

- In spot welding, if both bottom and top electrodes are replaced by rotating wheels it is called seam welding.

- In resistance seam welding, the welding electrodes are motor driven wheels as opposed to stationary rods. The result is a rolling resistance weld or non-hermetic seam weld.

- The spot welding is not continuous one where as seam welding is used to produce continuous joint between two overlapping pieces of sheet metal.

## Process :

- In seam welding, overlapping sheets are gripped between two wheels or roller disc electrodes and current is passed to obtain either the continuous seam overlapping weld nuggets or intermittent seam i.e. weld nuggets are equally spaced.
- welding current may be continuous or in pulse form.
- The electrically conducting rollers produce spot weld when the current reaches a high value.
- This process can be carefully controlled to produce continuous seam.
- The workpieces are placed between two rotating wheel electrodes as shown in fig. 2.11.
- When electric current is passed through electrodes high heat is produced on the workpieces between wheels.
- At the same time, the pressure is applied to complete the weld.
- The workpiece continuously moved in between the wheels.

- Thus, the leak proof continuous seam is achieved by supplying coolant to the electrodes.

- Finally, it speeds up the welding process.

- Resistance seam welding can be inappropriate where sharp corners in the seam required.

- To prevent warping of parts as the seam is created, good workpiece fixturing is necessary with this method.

- Surfaces must be kept very clean.

Types of seam welding:

- The following four types of resistance seam welding are possible.

(a) Conventional resistance seam-welding,

(b) overlapping spot seam weld.

(c) Roll spot welds

(d) Mash-seam welding.

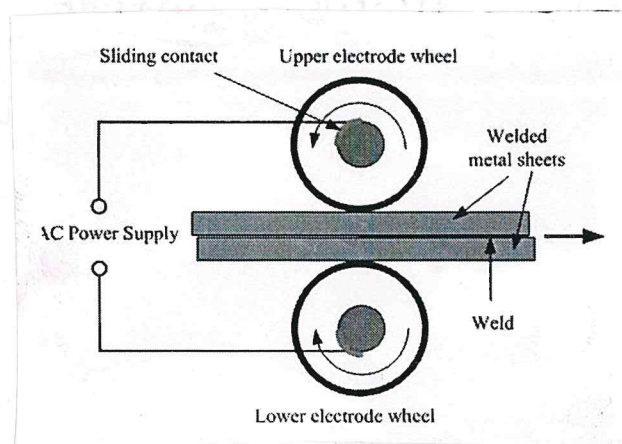



## Advantages :

1. Gas tight as well as liquid tight joint has been made
2. The overlap is less than spot or projection welding.
3. The production of single seam weld and parallel seams can be got simultaneously
4. This method is efficient energy use.
5. Filler materials are not required and hence, there are no associated gases and fumes.
6. It produces clean welds.

## Limitations :

1. The welding process is restricted to a straight line or uniformly curved line.
2. The metals sheets having thickness more than 3mm can cause problems while welding
3. The design of the electrodes may be needed to change to weld metal sheets having obstructions.
4. It requires complex control system to regulate the travel speed of electrodes as well as the sequence of current to provide

Satisfactorily overlapping welds. The welding speed, spots per inch and timing schedule are all dependent on each other.

5. Relatively higher current is thus required for seam welding than for spot welding.

6. The work pieces to be welded should overlap sufficiently to prevent metal flowing out from the edges of the pieces during welding under pressure.

### Applications:

1. It is used to make tin cans, leak proof tanks, automobile mufflers, gasoline tanks drums, radiators, household utensils, transformers, refrigerators, evaporators and condensers, automobile bodies etc. It is also used for welding thin sheet.

2. Circumference weld is possible in rectangular or square or even in circular shapes.

3. Most of the metals can be welded.

4. Butt welding can be done for producing seam welded pipes and tubes.

### Projection Welding:

#### Principle:

- Projection welding is an electric resistance welding process that uses small projections, embossments or intersections on one or both components of the weld to localized the heat and pressure.

#### Procedure:

- Projection welding is one kind of resistance welding which is developed from spot welding.
- In this type of welding, a series of spots are welded at a time.
- The metal pieces to be welded are placed between two metal arms which act as electrodes.
- One of the work pieces has projections on its surface.

- The workpieces are clamped between anodes. When AC power is supplied, the welding current passes through these projections.

- The heat is produced at the contact point of the base metal because of high electrical resistance. Now, the workpieces are pressed together by bringing down the upper electrodes.

- The projections are made into flat under pressure and the two pieces are joined together by a strong weld at all points to contact.

- The surface at the projection must be clean before welding.

- There should not be any scale, dirt and grease on the surface.

- An un-cleaned surface will reduce the resistance to the current flow. So the joint will be weaker.

- Projection welding is used for joining thin sheet metals of thickness up to 3mm. It is used in automobile industries.

- A wire or rod may be easily welded on its length of a flat surface. This welding process is used in mass production.

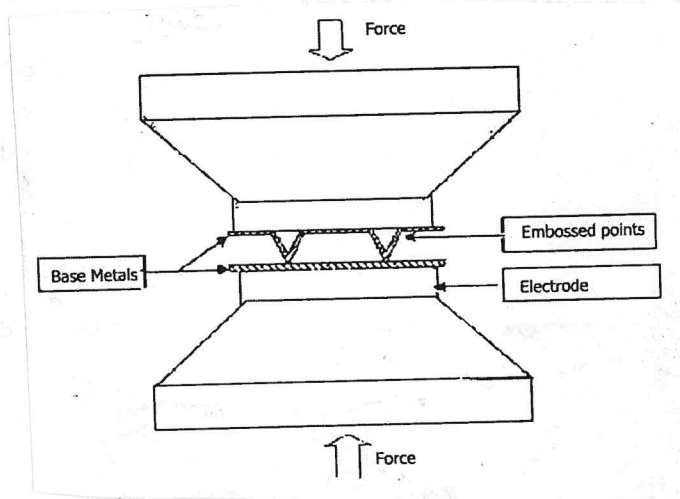

### Advantages:

1. More than one weld can be made simultaneously.
2. It can weld metals of thickness which is not suitable for spot welding.
3. Projection welding electrodes have a longer life when compared to spot welding electrodes, because the projection welding electrodes have to withstand less wear and less heating.
4. Resistance projection welding is not limited to sheet to sheet joints.
5. Projection welding can be done at specific points which are desired to be welded.

6. In difficult welding work, Projection welding gives a better heat balance.

7. Projection welding saves electricity because it needs less current to produce heat. So it reduces the shrinkage and distortion defects.

8. Heat treated parts can be easily welded without affecting the heat treatment.

9. Parts with different thermal conductivities and mass can also be welded.

10. Welds can be varied without producing flash or upset at the joints.

11. Welding current and pressure required is less.

12. It is more suitable for automation.

13. Filler metals are not used. Therefore, clean weld joints are produced.

### Limitations :

1. All types of metals cannot be welded using projection method. Metal thickness and composition are the challenging factors.

2. Projection cannot be made in thin workpieces.

3. All the metals are strong enough to support the projections. Some brasses and coppers cannot be welded satisfactorily using projection welding.

4. There is an extra operation required called forming of projection.

5. Projections need to have same heights for an appropriate welding.

6. The area which is less than 650 mm<sup>2</sup> cannot be welded by projection welding process.

7. Projections cannot be made in thin workpieces.

8. Thin workpieces cannot withstand the electrode pressure.

9. Equipment is costly.

### Applications:

1. It is used to make press-tools.

2. This process is more suitable for cross welding of a number of wires or rods which is commonly used to make wire fencing, shopping carts and stove grills.

3. Projection welding is mainly used in automobile sector.

4. Fasteners can be welded to surfaces when the fastener has machined or formed projections on its head.

5. It is used in reintegration work such as condensers, grating, racks etc.

### Resistance Butt Welding.

- It is one kind of resistance welding.

There are two types of resistance butt-welding namely,

1. Upset butt welding,

2. Flash butt welding,

- Upset Butt-welding:

- For making upset welding edges of the workplace should be cleaned perfectly and flatten.

- The parts to be welded are clamped in copper jaws as shown in Figure-2.15

- The jaws act as electrodes. Both work pieces edges are prepared and butted together.

- There may be some gap between parts but it should be such that no arcing takes place.

- Then the jaws are brought together in a solid contact when the current flows



through the points of contact of jaws to form a locally of high electrical resistance.

• All this point, the applied pressure upsets or forges the parts together.

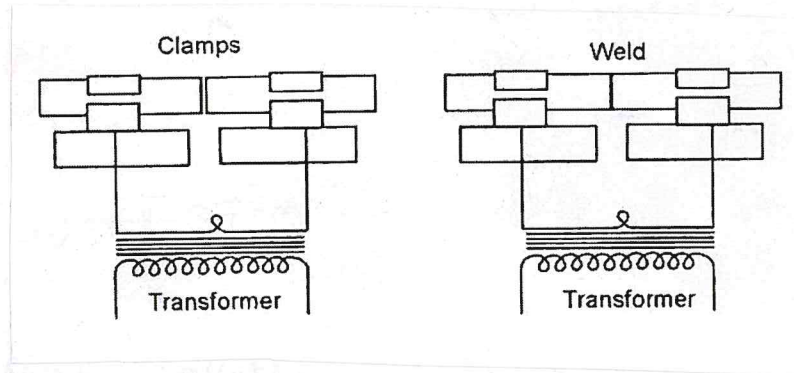

### Advantages:

1. Upset butt-welding is more suitable for welding many alloys which are difficult to weld fusion welding.
2. The metal retain base metal characteristics because the base metal does not melt during welding.
3. The welded joint is stronger because the hot working structures is maintained.
4. The introduction of composite materials and inclusion of secondary materials on the base metal are almost minimal.

5- Upset welding is mainly adapted to fabricate very large structures compared to conventional resistance welding.

### Applications :

1. This process is mainly used for welding nonferrous materials of smaller cross section such as bars, rods, wires, tubes etc.

2. Upset welding is used to make closure of capsules, small vessels and containers.

3. It is applied in welding steel rails.

### Flash Butt-welding :

• The welding process in which the ends of rods are heated and fused by an arc struck between them and forged to produce a weld is called flash butt welding.

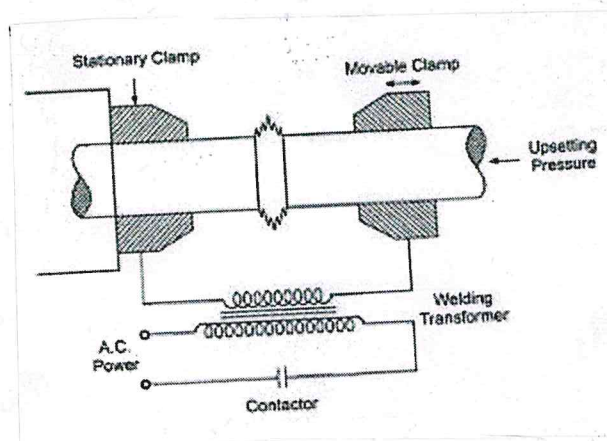

● In this process, the parts to be welded is clamped in copper jaws of welding machine.

● One of these jaws is stationary and the other one is made as movable.

● They act as electrodes.

● The jaws are water cooled as they are connected to the heavy current electric power supply.

● The workpieces are brought together in a set contact.

● When the current flows through the workpieces, an electric arc of flash is produced.

● The ends reach fusing temperature and power is switched off.

● Now, the ends are forced together by applying mechanical force to complete the weld.

● In this welding, a small projection is produced around the weld.

● That projection is finished by grinding. welded parts are often called to improve the toughness of the weld.

● This process is used for the part having larger cross section. This process is suitable for welding steel and ferrous alloy other than cast iron.

## Advantages:

1. Many dissimilar metals with different melting temperature can be flash welded.
2. Flash butt welding allows fast joining of large and complex parts.
3. Power consumption is less.
4. Clean welds can be made.

## Applications:

1. Butt welding is used in automobile construction of the body, axle wheels frames etc. Non-ferrous alloy such as lead, tin, zinc, antimony, bismuth and their alloys cannot be welded by this method.

2. It is also used in welding motor frames, transformers tanks and many types of sheet steel containers such as barrels and floats.

## Percussion Welding:

• It is one type of resistance butt welding process.

• The parts to be welded are clamped in copper jaws of the welding machine in which one clamp is fixed and other one is movable.

● The movable clamp is backed up against the pressure from a heavy spring.

● The jaws act as electrodes. Heavy electric current is connected to the workpieces.

● Now, the movable clamp is released rapidly and it moves forward at high velocity.

● When the two parts are approximately 1.6 mm apart, a sudden discharge of electrical energy is released thereby causing an intense arc between two surfaces.

● The arc is extinguished by the percussion blow of the two coming together with sufficient force to complete in 0.1 second.

● No upset or flash occurs at the weld.

● This method is primarily employed to join dissimilar metals.

● This method is limited to small areas of about 150 to 300 mm.

● welding energy,  $E = .5 CV^2$

● where  $E$  = energy in watt seconds (Joules),

$C$  = Capacitance in farads,  $V$  = Voltage.

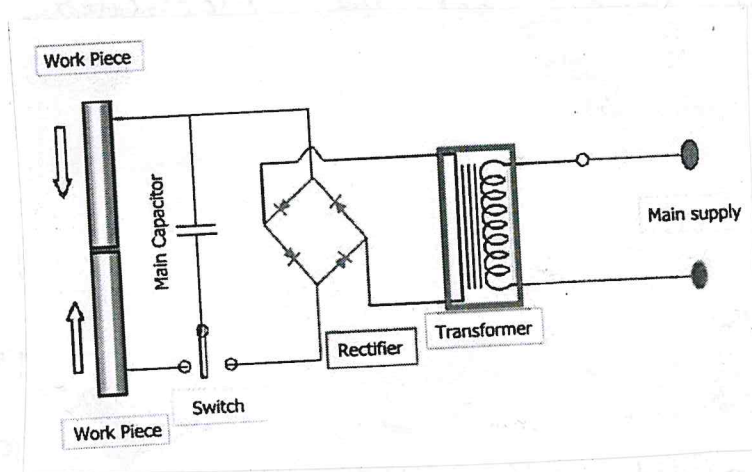

- Amount of energy required to make joints depends on the following factors.
  - Cross sectional area of the joints.
  - Properties of work metal.
  - Depth to which metal is melted.

### Advantages:

1. The time cycle involved is very short.
2. Shortness of arc limits melting and heating.
3. Heat-treated and cold worked materials can be welded without annealing.
4. No filler metal is required.
5. No cast structure is produced at interface.

6. charging rate is low and controlled

7. It can tolerate some contamination on faying surface.

8. Welding of dissimilar metal and copper to steel is possible.

9. These welders have a long wear life for welding jaws due to very short relatively low current welding pulse.

10. Welding of metals with high melting point such as tungsten, molybdenum etc. are possible by this method.

### Limitations:

1. The welding process is limited to butt joints.

2. Total area is limited.

3. Similar metals can usually be joined more economically by other processes.

4. The process is usually confined for joining of dissimilar metals not normally considered weldable.

5. Welding is typically dirtier and less smooth than resistance welding.

6. With nib start percussive arc welding, a starting nib must be cut onto workpieces.

7. The workpieces must be free of oil or dirt.

### Applications:

1. It is used for fine wire leads to filaments such as in lamps and electric components.

2. The method is also used to weld pins, studs, bolts and so on.

### High Frequency Resistance Welding:

#### • High-Frequency Resistance Welding (HFRW)

describes a group of processes that use high frequency electric current to concentrate the welding heat at the needed location.

• The process is similar to seam welding but it uses high frequency current.

• The required frequency is up to 450 kHz.

• The required frequency is passed between electrodes in contact with the edges of a strip forming a tube when it passes through forming pressure rolls.



● Figure 2.19 Shows schematic of high frequency resistance weld used for making pipes. The Pressure rolls apply the required welding pressure.

● The required welding heat is governed by the current passing through work and speed of tube movement.

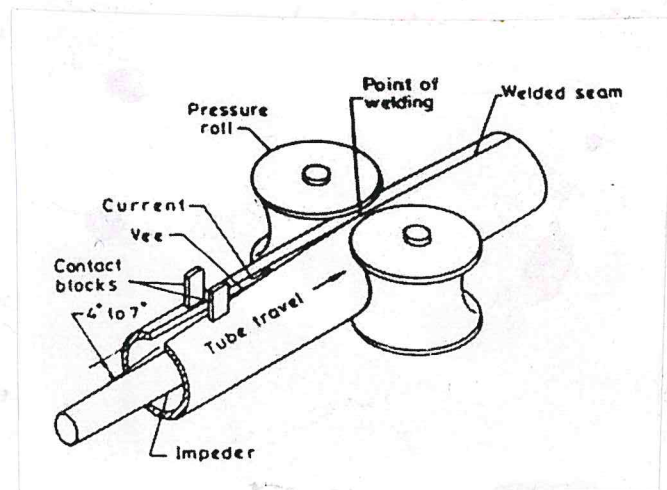

● High - Frequency current in metal conductors tends to flow at high densities along surfaces at a shallow depth known as skin effect.

● Due to this only a small amount of metal is heated at the welding interface.

- The Processers produce welds at high speeds at very high energy efficiency.

- They are generally prepared for welding in a continuous roll forming strip mill where the flat strip is gradually shaped to a round form.

- In the weld area, open edges of the formed strip are brought together by pressure rolls to form a vee shape with the apex at the weld point.

- The preferred vee angle for roll forming is between 4" to 7.

### Advantages:

1. High - Frequency resistance welding is more efficient because the distance between point of weld and sliding contacts is shorter and there are no induction losses.

2. It is suitable for long production runs where coils of strip are butt welded which is an end to end welding process to avoid the need to stop and restart the line.

3. It needs less energy efficient than contact welding.

4. Weld quality is not sensitive to the presence of air around the weld.

## Limitations:

1. The contact wear requires maintenance and replacements.
2. It cannot be used at slow speeds or as a manual process.
3. The stop and restart will cause visual objectionable discontinuities.

## Applications:

1. The predominant application of this type of welding is continuous manufacturing of pipe and tubing.
2. It is more suitable for high speed welding of a large range of sizes and materials.
3. Steels, stainless steels, aluminium, copper, brass and titanium are successfully welded by High-Frequency resistance welding processes.
4. It is used in making tubing, I-beams and wheel rims.

Applications:

1. The contact between the two surfaces is maintained throughout the process.
2. The contact is made at slow speeds.
3. The manual process.
4. The gap between the two surfaces is maintained throughout the process.

Applications:

1. The predominant application of this type of welding is in the manufacture of pipes and tubes.
2. It is used for the repair of large vessels of steel and materials.
3. It is used for the repair of steel, aluminium, copper, brass and titanium are successfully welded by this process.
4. It is used in making tubing.
5. It is used in making tubing.

## UNIT - III

### Solid State Welding Processes.

Cold welding, Diffusion bonding, Explosive welding, Ultrasonic welding, Friction welding, Forge welding, Roll welding, and hot pressure welding processes - advantages, limitations and applications.

#### Cold welding:

- Cold pressure welding is a form of solid state welding which is unique because carried out at ambient temperature.
- Other forms of solid state welding are conducted at elevated temperature.
- Cold welding is a bonding process during which two solids are forced to form a single piece by applying adequate pressure as shown in figure.
- In other words, cold welding is a solid - state welding process in which joining of metals takes place without fusion / heat at the interface of two parts to be welded.

- Cold welding is also known as Contact welding. In fusion processes, no liquid or molten phase is present at the joint.

- In cold welding, metals are joined together without using flux.

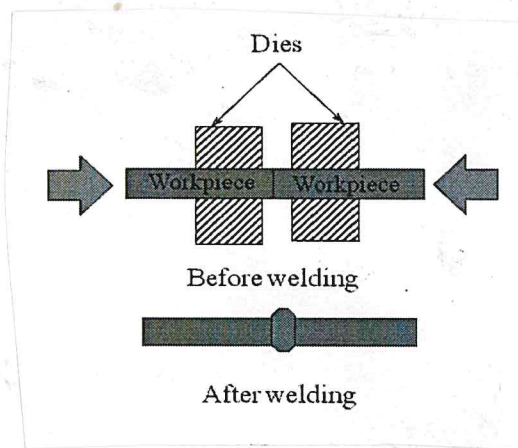

- The welding of parts is done by extreme high pressure or by contact in a high vacuum with no application of heat.

- Pressure is applied to points to be welded at temperature below the recrystallization temperature of metals to be welded.

- This applied pressure brings the atoms on the interface to be welded into such close contact that they diffuse across the interface and a cold pressure weld is made.

- The atoms of metals are held together by metallic bond.

- The metallic bond can be described as a 'cloud' of free and negatively charged atoms into a unit as a result of attractive forces.

- All metals are surrounded by surface layers (oxide) which must be disrupted if they need to be welded.

- Cold pressure welding carried out at ambient temperature relies upon the use of high compressive pressure 1400 to 2800 N/mm for Aluminum and at least double that value for copper.

- It provides interfacial deformations of 60% to 80% that break the oxide layers to expose fresh and uncontaminated metal makes contact.

- In this state, take over to inter atomic forces produce the weld.

- During cold welding, both surfaces continue to remain in solid phase throughout this forced adhesion process.

- The parts to be welded are first cleaned.

• A short section of parts to be welded is sheared as shown in figure 3.3(a)

• The parts are clamped in a die with some initial extension.

• A forging force is applied to complete welding.

• Various stages of multiple upset cold welding of wires are shown in figure 3.3, figure 3.4, shown the parts to be welded before welding and after welding has been carried out.



- It is a method used for relatively ductile metals such as aluminium, copper, cupro-nickel, gold, silver, platinum, lead, zinc, tin and lead-tin alloys, nickel, palladium and cadmium, etc., and it is particularly suited to welds in circular wire section.

- Dissimilar materials and materials of different sizes can all be welded.

- Both butt and lap joints can be cold welded.

- Where the application demands the joining of lapped sheets to themselves or bars, a series of small welds can be used.

- When calculating strength, the designer should consider that at least half the thickness of one of the sheets will be lost due to the applied pressure.

- Butt joints are primarily used for joining wires and rods in diameters from 0.5 mm up to 12 mm.

- The dies play an important role in a cold butt weld process.

- First, they must grip the material firmly.

- Therefore, the inside of the cavity either etched or made with an electric pencil.

- The gap between two faces or names of the die is also important.

- If it is too large, the material will just collapse or bend away.

- This dimension is taken care of during manufacture and it cannot be changed.

- Dies can also be manufactured to suit various profiles as long as the profile allows the die to be made in two halves.

### Characteristics of Cold Welding:

- A Cold weld is generally stronger than the parent material and has the same electrical characteristics.

- At least one of the metals must be ductile without expensive work-hardening.

- Total absence of applied heating occurs.

- Surface preparation is important.
- Both workpieces can be similar or dissimilar metals.

## Advantages:

1. There are no thermal effects on the parts being joined and the process is fast.
2. As the process is performed at ambient temperature, there are no thermal effects on the parts being joined.
3. The weld zone is not only metallurgically homogeneous but the metal is work hardened and stronger than the adjacent areas.
4. It is simple and inexpensive to operate once dies have been produced.
5. The process is fast.
6. It is virtually no deformation.
7. The ends of the wire or rod need no surface preparation to weld and the alignment of the two busnet ends is automatic as the material is placed on the die.
8. Parts are joined without contamination from sparks or dusts and vapours.

## Limitations:

1. As the welds are made in the solid state, they are difficult to inspect.
2. The thickness of the parts is reduced significantly at the weld where the contact surfaces are shared together.
3. It is highly specialized type of welding with respect to joint design and materials to be welded.
4. While the speed is an advantage to assemblers, it can also be a limitation.
5. When a body moving that fast meets another, it will try to displace it.

## Applications:

1. It is used for joining of wire, foil to wire, wire to hi-metals and sealing of heat sensitive containers such as those containing explosives.
2. Rod coils are built welded to permit continuity in post-weld drawing to smaller diameters.
3. It is used for joining components where heating is not possible such as magnets.
4. In the electronics industry, cold welding processes are used to seal tin plated steel crystal cans and copper packages for heat sensitive semiconductor devices.

## Diffusion welding:

- It is a solid state welding process that uses heat and pressure, usually in a controlled atmosphere, with sufficient time for diffusion and coalescence to occur.
- In this process, moderate pressure of about 10 MPa is applied to carefully deaired surfaces of the workpieces at an elevated temperature below the melting point of the metals to result primarily from diffusion.
- Atoms diffuse across the interface to form the bond. Diffusion involves the migration of atoms across the joint due to concentration gradients.
- This process requires temperature of about  $0.6T_m$  ( $T_m$  is the melting temperature of the metal) in order to have a high diffusion rate between parts being joined.
- Here, plastic deformation at surfaces is minimal and primary coalescence mechanism is solid state diffusion.

• When joining two materials of similar crystalline structure occurs, diffusion bonding, is performed by clamping two pieces to be welded with their surfaces abutting each other.

• Prior to welding, these surfaces must be machined to smooth finish and kept free from chemical contaminants or other debris.

• Mostly, surface treatment including polishing, etching and cleaning as well as diffusion pressure and temperature are important factors.

• Surface roughness value,  $R_a$  less than 2 micron and waviness of less than 100 micron are preferred oxides need to be removed.

• Diffusion bonding is performed under controlled atmosphere to prevent oxidation.

• Sometimes, a layer of filler material is needed to achieve good bonding.

• Any intervening material between two metallic surfaces, as shown in figure 3.5, may prevent adequate diffusion of material because the strength of the welding depends on pressure, temperature, time of contact and cleanliness of the metal.

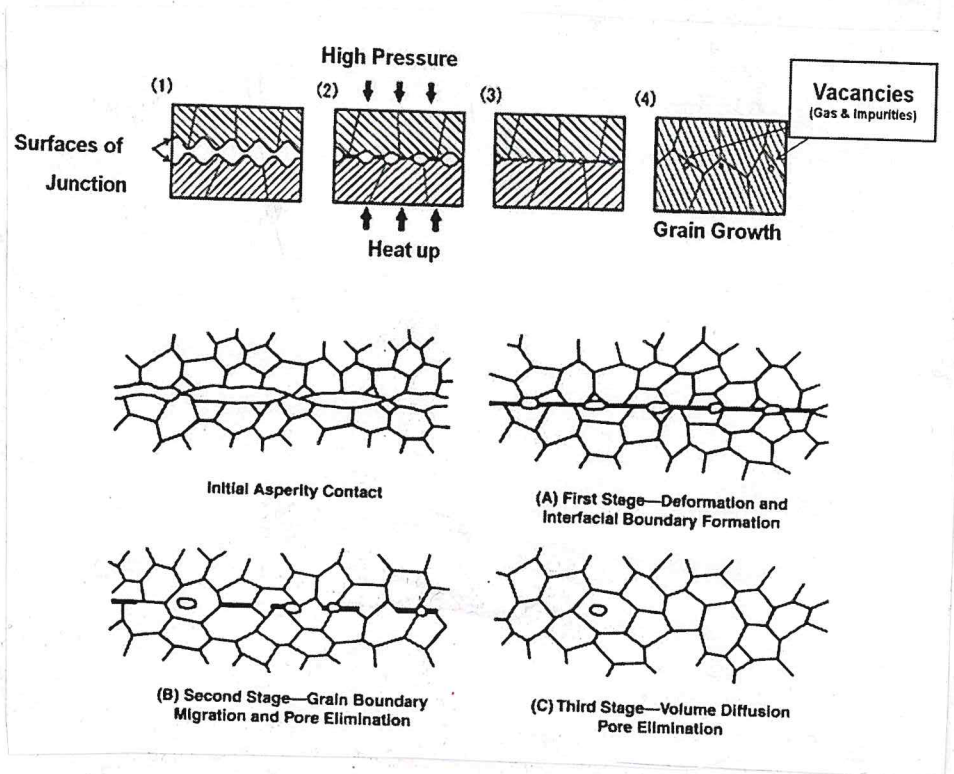

## Advantages, Limitations, and Applications of

### Diffusion welding

#### Advantages:

1. Plastic deformation at surface is minimal.
2. Dissimilar materials may be welded.
3. Welds of high quality are obtained.
4. There is no limitation in the thickness of workpieces.
5. The bonded surface has the same physical and mechanical properties as the base materials.

6. The diffusion bonding is able to help us to build high precision components with complex shapes. Also, the diffusion is flexible.

7. The diffusion bonding method can be used widely, joining both similar or dissimilar materials and also important in processing composite materials.

8. The process is not extremely hard to approach and the cost to perform the diffusion bonding is not high.

9. The diffusion bonding process is able to produce high quality joints in which no discontinuity and porosity exists in the interface.

### Limitations:

1. It is a time consuming process due to low productivity.

2. Time required for diffusion can range from seconds to hours.

3. Very thorough surface preparations is required prior to welding process.

4. The mating surface must be precisely fitted to each other.



5. It requires relatively high initial investments in equipment.

### Applications:

1. It is used in joining of high-strength and refractory metals based on titanium in aerospace and nuclear industries.

2. Diffusion welding is most commonly used to join sheet metal structures in nuclear and electronics industries.

### Explosive Welding:

- Explosive welding (Exw) is a solid state (solid-phase) welding process that uses a controlled application of large pressure generated by the detonation of applied explosives.

- In explosive welding, welded parts (plates) are metallurgically bonded as a result of oblique impact pressure exerted on them by a controlled detonation of an explosive charge.

- The following terms are frequently used in the explosive welding.

- cladding metal or cladder is the thinner plate that is either in direct contact with the explosive or it is shielded by a flyer plate from the explosive.

- Flyer plate is a sacrificial plate placed between bladder and explosive to protect the cladder metal.

- Interlayer is a thin metal layer which is sometimes placed between cladder and base plate to enhance joining.

- Base plate or backer is the plate that the bladder is being joined.

- Anvil is the surface on which backer rests during the joining operation.

- Standoff is the distance between bladder and base plate prior to the joining operation.

- Bond window is the range of process variables such as velocity, dynamic bend and standoff distance that - result in a successful weld.

- Bonding operation is the detonation of the explosive which results in the weld.

- Before welding, the surface to be welded must be cleaned.

- To carry out the welding process, one of the parts to be welded is kept stationary and the other one is made movable.

- The movable part is called flyer plate

- The base plate kept as stationary is rested on an anvil and the flyer plate is located above the base plate with an angled or constant interface clearance as shown in figure 3.8 (a)

- On top of the flyer plate, the rubber spacer is placed to avoid the rapid effect of burnt explosive. Explosives are placed

propagates at high velocity  
on this rubber spacer with a detonator.

- Detonation starts at an edge of the plate and propagates at high velocity along the plate.

- The flyer plate moves towards the base plate at very high velocity (4 to 5 km/s)

due to the impact of kinetic energy in the form compressive stress during detonation of explosives to collide with a stationary part to be joined.

- The maximum detonation velocity is about 120% of the material sonic velocity.

- The compressive stress is in the order of thousands of MPa

- The material at the intersection points behaves similar to a viscous fluid after explosion.

- The slags (oxides, nitrides and other surface contaminants) are expelled by the metallic jet is created just ahead of the bonding front as shown in figure 3.8 (b)

- It also creates wavy surface as shown in figure 3.9.

- During bonding, normal inter-atomic and intermolecular force takes place between these two surfaces.

- During the process, the surrounding material is work hardened by the shockwave and there is no metallurgical changes occur.

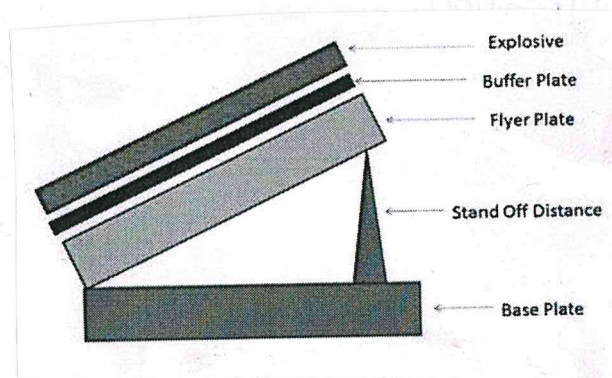
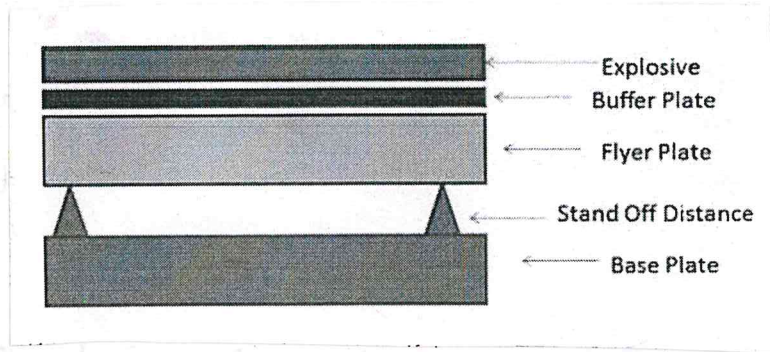

## Advantages, Limitations and Applications of

### Explosive Welding :

#### Advantages :

1. It ensures high quality bonding such as high strength, no distortions, no porosity and no change of the metal microstructure.
2. There is no heat-affected zone (HAZ) other than weld surface.
3. There is no diffusion.
4. Only, minor melting occurs.

5. Differences in material melting temperatures and coefficients of thermal expansion do not affect the final product.

6. Combination of dissimilar metals, copper to stainless steel, aluminum to steel or titanium to steel can be easily welded.

7. Explosive welding is much suited to cladding application.

8. Process is simple and rapid. It also gives close thickness tolerance.

9. Low melting point and low impact resistance materials cannot be effectively welded.

10. Large surfaces may be welded.

11. It is less costly.

12. Surface preparation is not required.

13. Large areas can be bonded quickly and the weld itself is very clean due to surface material of both metals.

14. Minimum fixturing/jigs are needed.

15. There is no effect on parent material properties.

16. Small quantity of explosive is used.

## Limitations:

1. Brittle materials cannot be processed.
2. Only, simple shape parts may be bonded.
3. Thickness of flyer plate is limited.
4. Safety and security aspects of storage and using explosives are difficult.
5. Metals must have high enough impact resistance and ductility.
6. The geometrics welded must be simple in the shape of flat, cylindrical and conical shapes,
7. The cladding plate cannot be too large.
8. Noise and blast can require worker protection, vacuum chambers and buried in sand/water.
9. The use of explosives in industrial areas will be restricted by the noise and ground vibrations caused by the explosion.
10. Area should be cleaned and sound grounded for explosion.
11. Licenses are necessary to hold and use explosives.

## Applications:

1. The process is applied to welding of tubes and tube plates in heat exchangers, feed water heaters and boiler tubes to clad tube plates.

2. The tubes may be of steel, stainless steel, or copper, aluminium brass and bronze tubes in naval brass tube plates are welded.

3. It is used for manufacturing clad tubes and pipes, pressure vessels, aerospace structures, heat exchangers, bi-metal sliding bearings, ship structures and weld transitions.

4. This is used to clad thick plates with corrosion resistant layers where other techniques (e.g. roll bonding) are not practical.

5. It is used in tube plugging.

6. It is used in remote joining in hazardous environments.

7. It is used in fixing cooling fins.

8. It is also used in cryogenic industries.



## Ultrasonic welding:

• Ultrasonic welding is a solid state welding process in which two work pieces are bonded as a result of a pressure exerted to ~~welded~~ welded parts combined with application of high frequency acoustic vibration (ultrasonic).

• It uses the principle of conversion of high frequency electrical energy into high frequency mechanical energy. The mechanical energy is a vertical motion excess of 15000 cycles second.

• Ultrasonic vibration causes friction between parts which results in a closer contact between two surfaces with simultaneous local heating of the contact area.

• Interatomic bonds formed under these conditions provide strong joint.

• The components to be joined are held together under pressure and subjected to

• Vibrations, usually at a frequency of 15 KHZ to 60 KHZ.

• The vibrations produced by a welding sonotrode of sonometer or horn are used to soften or melt the thermoplastic material at the joint time.

- Welding times are lower than 3 seconds.
- The welding can proceed with or without the application of external heat.
- Thickness of the welded parts is limited by the power of the ultrasonic generator.

### Ultrasonic Welding Equipment:

- Ultrasonic welding equipment consists of a machine press, generator, converter or transducer, booster, sonotrode or horn and component support tooling.
- A schematic of an ultrasonic welding machine is shown in figure 3.11

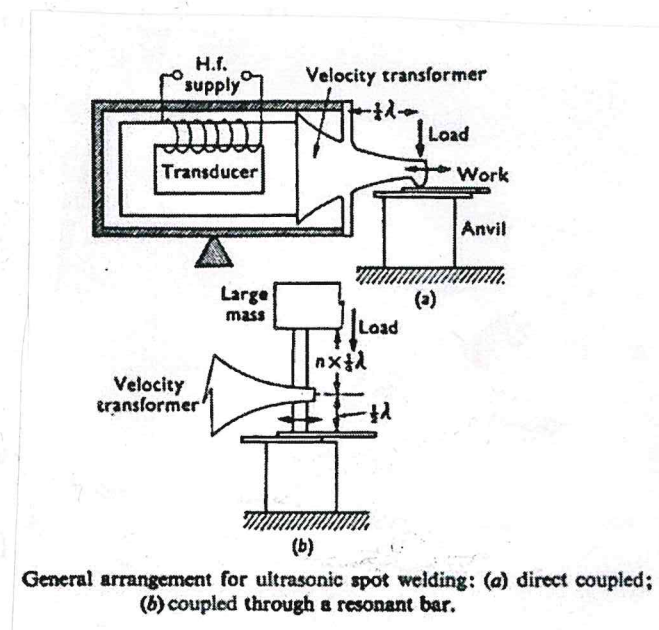

## • Generator:

- The generator converts electrical power from the single-phase mains to the correct frequency and voltage for the transducer to convert into mechanical vibrations.

- The microprocessor unit controls the welding cycle and feeds back the key welding information to the user interface also allows the operator to enter the required welding parameters.

## • Machine Press:

- The machine stand is designed to hold the welding system or stack and it applies the force necessary for welding it consists of a base-plate to hold the tooling jig and a pneumatic cylinder to apply the force.

- The machine has a pressure gauge and regulator for adjustment of the welding force.

- There is also flow control valve to allow adjustment of the speed at which the welding head approaches the component being welded.

- Some equipment manufactures have introduced an electromagnetic force application system in place of the traditional pneumatic cylinder.

- It gives a better control of the approach rate and it can be beneficial when welding small or delicate components.

### • Welding Stack:

- It is a part of the machine that provides the ultrasonic mechanical vibrations.

- It is generally a three-part unit consisting of transducer, booster and welding horn which are mounted on the welding press at the centre-point of the booster section.

- The stack is a tuned resonator similar to a musical instrument tuning fork.

- In order to function, the resonant frequency of the tuned welding stack must closely match the frequency of the electrical signal from the generator (within 30 Hz).

### • Transducer:

- The transducer is also known as converter which converts the electrical energy from the generator to the mechanical vibrations used for the welding process.

- Transducers are made of pizo-electric materials.
- A piezo-electric material increases its length when current flows through a coil surrounding the device and it changes the alternating electric field into mechanical movement.

- Examples of piezoelectric materials are quartz, tourmaline and Rochelle salt.

- Transducer consists of a number of piezo-electric ceramic discs sandwiched between two metal blocks, usually titanium.

- Between each of the discs there is a thin metal plate which forms the electrode. As the sinusoidal electrical signal is fed to the transducer via the electrodes, the discs expand and contract, and produce an axial and peak-to-peak movement of 15 to 20 $\mu$ m.

- Transducers are delicate devices and they should be handled properly. Once elements are broken, the transducer will not function.

## • Booster:

- The booster section of the welding stack serves two purposes, primarily to amplify the mechanical vibrations produced at the tip of the transducers and transfer them to the welding horn.
- Its secondary purpose is to provide a location for mounting the stack on the welding press. The booster expands and contracts as the transducers apply ultrasonic energy.
- The booster similar to other elements in the welding stack is a tuned device.
- Therefore, it must resonate at a specific frequency in order to transfer the ultrasonic energy from the transducers to the welding horn.
- In order to function successfully, the booster must be either one half of a wavelength of ultrasound in the material from which it is manufactured or it multiples of this length.
- Normally, it is one half of the wavelength.

## • Welding horn

- The welding horn is the element of the welding stack that supplies energy component being welded.

- A typical welding horn is shown in Figure 3.12

- Design welding horn is critical to successful welding.

- The horn is specially designed to have the correct sonic properties and it transmits pressure to welded surfaces and it vibrates to make the weld.

- It must have good mechanical strength which makes the weld.

- It can be of cylindrical shape, bar shape or more complex shapes according to the parts to be welded.

- It's horn can be made of steel alloy, aluminium alloy or titanium which all have good ultrasonic properties.

- Aluminium welding horns tend to be used for low volume applications since wear can be a particular problem with this material.

- Some welding horns have specially hardened tips to reduce wear during welding.

- As with the booster element, the length of the welding horn must be either one half of a wavelength of ultrasound in the material from which it is manufactured or multiple of this length.

- It ensures that there is sufficient amplitude at the end of the welding horn to effect welding.

- The amplitude is typically between 30 and 120  $\mu\text{m}$ .

- The shape of the welding horn is important since stress caused by axial expansion and contraction of the horn could lead to cracking in high amplitude applications.

- In some applications, the welding horn is manufactured with slots in the axial direction.

- It is to ensure the maximum vibration amplitude in the longitudinal direction.



- The tip should be specially designed to match the component.
- The tip of the welding horn delivers the ultrasonic energy to the component being welded.
- It ensures the maximum energy transfer between horn and the component.
- Usually, the tip of the horn is profiled to match contours the component.

### • Support tooling:

- Finally, the base of the machine press supports the tooling which holds the components during welding operation.
- The support tooling is designed to prevent the movement of a lower component while the ultrasound is applied.
- It is machined to match the contours of the component surface intimately.

The sequence of cooperation is as follows:

Step 1: The parts to be welded are placed in a heating holder.

Step:2: The ultrasonic tool descends to apply calming pressure between the weld parts.

Step 3: When ultrasonic power flows for a given time, the tool then vibrates at a frequency 1-40 Hz.

Step 4: The base metals are then mechanically mixed causing a metallurgical bond between parts. The parts are immediately welded. There is no hold time or curing time.

Step 5: Force is removed and machine unloaded.

## Advantages, Limitations and Applications of ultrasonic welding:

### Advantages:

1. Since no bulk heating of the work pieces is involved, there is no danger of any mechanical or metallurgical bad effects.
2. The process is excellent for joining thin sheets to thick sheets.
3. Local plastic deformation and mechanical mixing result into sound welds.
4. Dissimilar metals may be joined.
5. High quality weld is obtained.

6. The process can be integrated into automated production lines.

7. Moderate operator skill level is enough.

8. The process is fast, economical and automated.

9. It is used in mass production up to 60 parts per minute.

10. It ensures increased flexibility and versatility.

11. It produces high strength joints.

12. Very thin materials can be welded.

### Limitations:

1. Only small and thin parts may be welded.

2. Work pieces and equipment components may fatigue at reciprocating provided by ultrasonic vibration.

3. Work pieces may bond to the anvil.

4. It is not suitable for ductile materials since they yield under the stresses.

5. It needs specially designed joints.

6. Ultrasonic vibrations can damage electrical components.

7. Tooling costs for fixtures are high.

## Applications :

1. Ultrasonic welding is used mainly for bonding small workpieces in electronics manufacturing communication devices, medical tools and watches.
2. It is used in automotive medical and toy production.
3. It is used in health care industries due to clean welds.
4. Ring-type continuous welds can be used for hermetic sealing.
5. It is used in sealing and packaging aircraft, missiles, and fabrications of nuclear components.
6. It is also used in armatures, slowed commutators, starter motor armatures, joining of braded brush wires, brush plates and wire terminals.
7. Ultrasonic welding is used in the automotive industry to fabricate headlamp parts, lamp assemblies and air ducts.
8. In electronic appliances such as switches, sensors and data storage keys are fabricated using ultrasonic welding.
9. Ultrasonic welding is also used to make medical parts such as filters, catheters, medical garments and masks.

10. It is used in welding of tubes to sheets in solar panels,

11. Packing applications such as blister packs, pouches, tubes, storage containers, and carton sprouts can be fabricated using ultrasonic welding.

## Friction welding:

### Principle:

• Friction welding is a solid state welding process in which coalescence is achieved by frictional heat combined with pressure as shown in figure. 3.14.

• The heat is obtained mechanical friction between rubbing surfaces of work pieces in relative motion another.

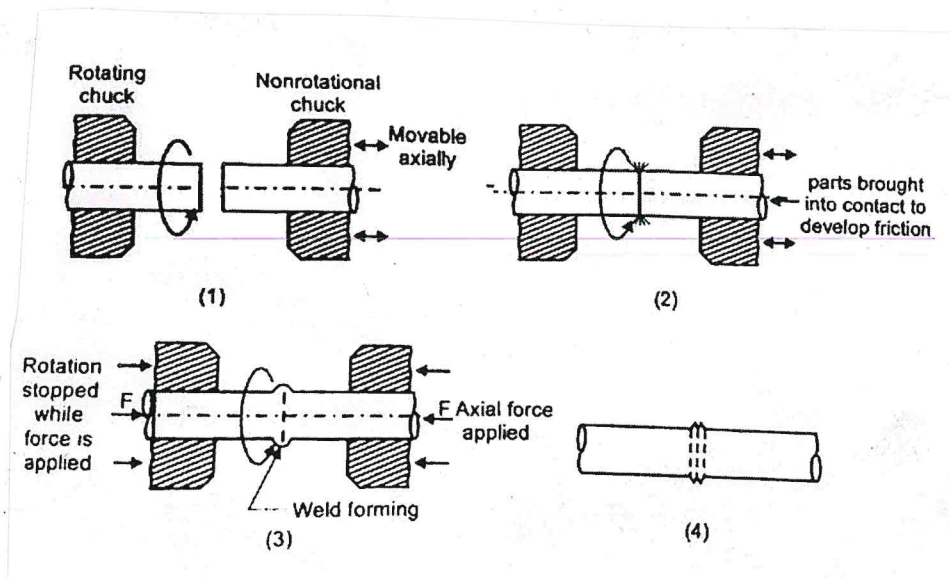

## Working:

- Initially, the components to be welded are held in chucks or clamps.
- One part is rotated at high speed (1500 to 3000 rpm) using rotating chuck and other part is held stationary using stationary chucks as shown in Figure. 3.15
- During welding, the stationary chuck is moved and conducted with the rotating components under pressure.
- The heat is produced between contact surfaces.
- The heat is used to weld the components under pressure.
- Pressure is used to generate sufficient heat to reach a bonding temperature within a few seconds. The pressure during welding varies between 40 MPa to 450 MPa.
- The heat is concentrated and localized at the interface.
- Grain structure is refined by hot work and there is little diffusion across the interface.

- During the period, the rotation is stopped and pressure is retained or increased complete the weld. Then, the metal is slowly extended from the weld region to form an upset.

- For stopping the relative motion, the brake system is used.

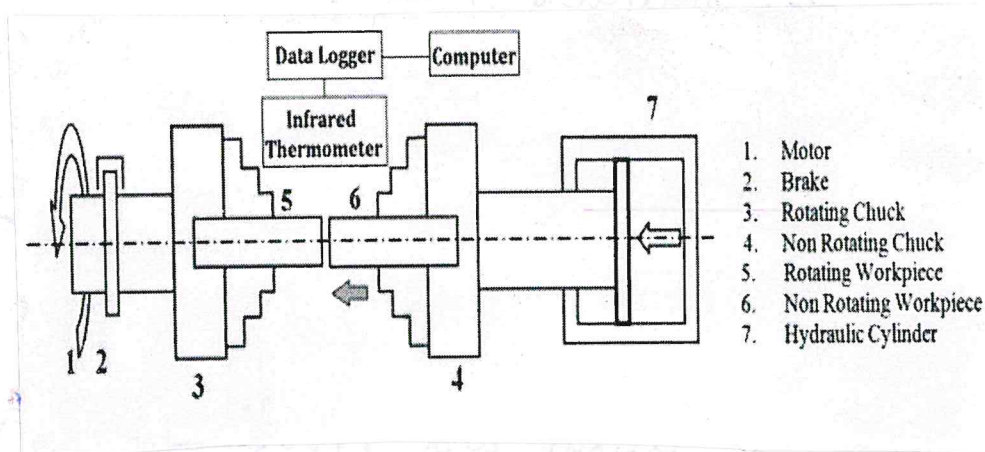

- When properly carried out, no melting occurs at facing surface during welding.

- No filler metal, flux or shielding gases are normally used. Process can be fully automated.

- It is possible to weld solid steel bars up to 250 mm in outside diameter by using friction welding.

- Variety of metals can be joined by this process as well as it gives variety of metals combination which cannot be joined by conventional process.

• The materials that can be welded using friction welding are listed as follows.

1. Brass and Bronze
2. Copper and Nickel
3. Lead.
4. Ceramics
5. Titanium alloys,
6. Stainless steel
7. Tungsten
8. Vanadium
9. Aluminium and aluminium alloys,
10. Magnesium alloys.

## Advantages, Limitations and Applications of Friction Welding

### Advantages :

1. Power Consumption is low,
2. The operation is easy and it used simple equipment,
3. Parameters are easily determined.
4. Less Time is required.
5. It's smooth and clean process.
6. Heat is quickly dissipated.
7. There is no need of using flux and filler metal.



8. There is no possibility of the driving unit stalling before the fly wheel energy is dissipated.

9. It easily joins dissimilar metals.

10. The full surface of the cross section is made up of both metals, airtight and absent of voids.

11. Friction welds have higher strength than other means of joining.

12. Friction welds often cost less.

13. Friction welds minimize the Heat Affected Zone (HAZ) as compared to conventional flash welding.

14. Friction welding minimizes the need to clean furnace residues from the entire part during post welding.

15. Consistent and repetitive process of complete metal fusion occurs.

16. Joint preparation is minimal.

17. There is no distortion and warping.

18. It greatly increases design flexibility.

19. It is environmentally friendly process

i.e. no fumes, gases or smoke generated.

20. It reduces machining labor thereby reducing perishable tooling costs while increasing Capacity.

21. Full Surface weld gives superior strength in critical areas.

22. It reduces raw material costs in bi-metal applications.

23. Reactive materials can be welded.

### Limitations:

1. It is used only for joining small parts, Heavy components are not possible to weld.

2. There is a possibility of heavy flash out.

3. Heavy rigid machines are required due to high thrust pressure.

4. Process is restricted to flat and angular butt welds.

5. Only limited shapes of joints can be welded.

6. Equipment cost is high.

7. In case of tube welding process, the process becomes complicated.

8. In case of high carbon steels, it is difficult to remove flash.

## Applications:

1. Because of high quality of the weld obtained, the process is widely accepted in aerospace and automobile industry for critical parts.

2. In aerospace industry, turbine blade joining, seamless joining etc, are produced using friction welding.

3. In automobile industry, bimetallic engine valve, axle shafts, universal joint yoke, gear hub etc. are produced using friction welding.

4. In Consumer Goods manufacturing, it is used for producing hand tools, sports equipment.

5. It is used in production cutting tools such as tapers, reamers and drills.

6. It is used for making simple forgings.

7. It is ideal for welding the spindles of the automobiles axle to its cage, welds piston eye to shaft and welding drill pie to drill rod.

## Forge Welding:

- Forge welding is solid state welding process in which components to be joined are heated to red hot working temperature and then hammered together.

- It may also consist of heating and forging with the metals together with presses or other means by creating enough pressure to cause plastic deformation at the weld surfaces.

- The process is one of the simplest methods of joining metals and it has been used since ancient times.

- The temperature required to forge weld is typically 50 to 90% of the melting temperature.

- Low carbon steel parts are heated to about  $1000^{\circ}\text{C}$

- Before forge welding is done, the parts are cleaned to prevent entrapment of oxides in the joint.

- Forge welding is adaptable for being able to join a host of similar and dissimilar metal. Forge welding between similar materials is caused by a solid state diffusion.

- It results in weld that consists of only the welded materials without any filler or bridging materials, Forge welding between dissimilar materials is caused by the formation of a lower melting temperature eutectic between materials.

- Due to this, the weld is often stronger than the individual metals.

- Forge welding is used in general blacksmith shops and for manufacturing metal art pieces and welded tubes.

- Mainly, automated forge-welding is a common manufacturing process in industries.

### Materials Welded by Forge welding process:

- Many metals can be forge-welded such as high and low-carbon steels.

- Iron and hypoeutectic cast-irons can be forge-welded.

- Some aluminium alloys and copper-based alloys can be forge-welded.

- Titanium alloys are commonly forge-welded.

### Forge welding process:

- The oldest forge-welding process is the manual-hammering method. Manual hammering is done by heating the metal to the proper

temperature, overlapping the weld surfaces and then striking the joint repeatedly with a hand-held hammer.

- The weld surfaces will be formed for the proper joint and then struck with a hammer to join them.

- The joint is often formed to allow space for the flux to flow out by beveling or routing the surfaces slightly and hammered in a successively backward fashion to squeeze the flux out.

- The hammer blows are used not as hard as for shaping and preventing the flux from being flung out of the joint at the first blow.

- After developing mechanical hammers, forge welding could be accomplished by heating the metal and then placing it between mechanized hammer and anvil.

- Mechanical hammers are operated by compressed air, electricity, steam, gas engines and many other means.

- Another method of forge welding is done with a die in which the pieces of metal are heated and then forced into a die which provides both the pressure for the weld and keeps the joint at the finished shape.

● Roll welding is another forge welding process where the heated metals are overlapped and passed through rollers at high pressures to create the weld.

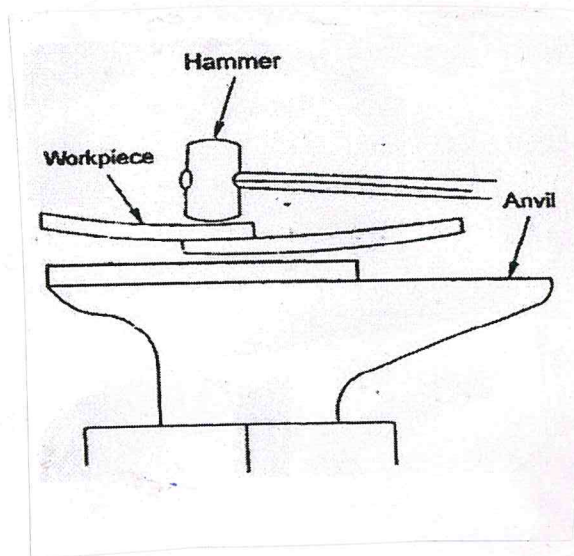

● Modern forge welding is automated using computers, machines and sophisticated hydraulic presses to produce a variety of products of various alloys.

● For example, the seam of a steel pipe is forge-welded during forming process. Diffusion bonding is a common method for forge welding titanium alloys in the aerospace industry.

### Advantages:

1. Good quality weld may be obtained
2. Parts of intricate shape may be welded.
3. No filler material is required.

## Disadvantages:

1. Only low carbon steel may be welded.
2. High level of operator's skill is required.
3. Welding process is slow.
4. Weld may be contaminated by the coke used in a heating furnace.

## Applications:

1. It is used in the production of pattern-welded blades.
2. It is used in the manufacture of Shotgun barrels.
3. In some cases, the forged & welded objects are acid-etched to expose the underlying pattern of metal which is unique to each item and it provides aesthetic appeal.

## Roll welding:

• Roll welding is a solid state welding process in which pressure sufficient to cause coalescence is applied by means of rolls, as shown in Figure 3.20, either with or without external heat.

• If the welding is done without applying heat, it is called cold welding and if the heat is used for welding, it is called hot roll welding.



- This process is similar to forge-welding except the pressure applied by means of rolls rather than by means of hammer blows.

- Coalescence occurs at the interface between two parts by means of diffusion at the faying surfaces, parts to be welded should be ductile and free of work hardening.

- Before the welding is carried out, the surface to be joined should be cleaned.

- If the parts to be welded are small, the pressure applied by rolls is done by using simple hand operated tools.

- For behaviour size parts, power presses are used to apply pressure.

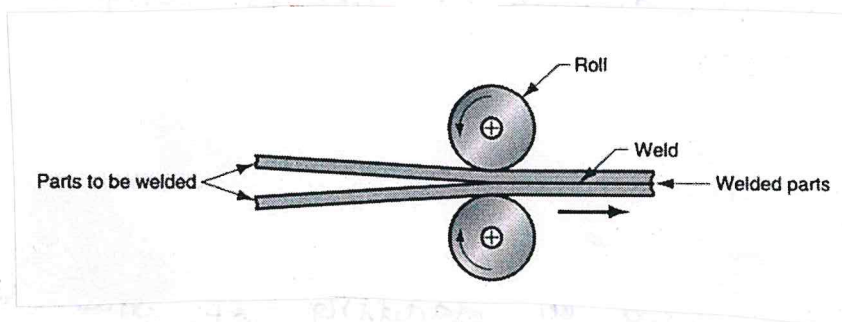

- One of the major uses of this process is the cladding of mild or low-alloy steel with a high-alloy material such as stainless steel.

- It is also used for making bimetallic materials for the instrument industry.

## Advantages:

1. Metals such as soft aluminium, copper, gold and silver can be easily welded by roll welding.
2. The operation is easy and it uses simple equipment.
3. There is no need of using flux and filler metal.
4. Environmentally friendly process i.e. no fumes, gases, or smoke generated.
5. It is smooth and clean process.
6. Less time is required.

## Limitations:

1. It needs extreme pressure to perform the welding process.
2. The cost of equipment is high.
3. Weld quality is less as compared to fusion welding.
4. It is limited to welding of flat shapes.

## Applications:

1. It is used in cladding of stainless steel to mild steel for corrosion resistance.
2. It is used in making bimetallic strips.
3. Roll welding is used to produce sandwich strips to convert it into coins.

## Hot Pressure Welding Process:

- Hot pressure welding is a solid state welding process which produces coalescence materials with heat and the applications of pressure sufficient to produce macro-deform of the base metal.

- During welding, the coalescence occurs at the interface between because of pressure and heat applied to produce an appreciable / noticeable deformation of surface crashes the surface oxide film and it increases the areas of metal.

- Welding this metal to the clean metal is accomplished by diffusion across interface.

- Therefore, the coalescence of the faying surface occurs.

- This type of operation is normally carried in closed chambers where vacuum shielding medium may be used.

- It is used primarily in the production of weldment for the aerospace industry.

- The variation in this process is the hot isostatic pressure.

- It means pressure is applied by means of a hot inert gas in pressure vessel.



- Generally, heat is applied by flames of oxy-fuel torches directed on the end surfaces of solid bars or hollow section to be joined.

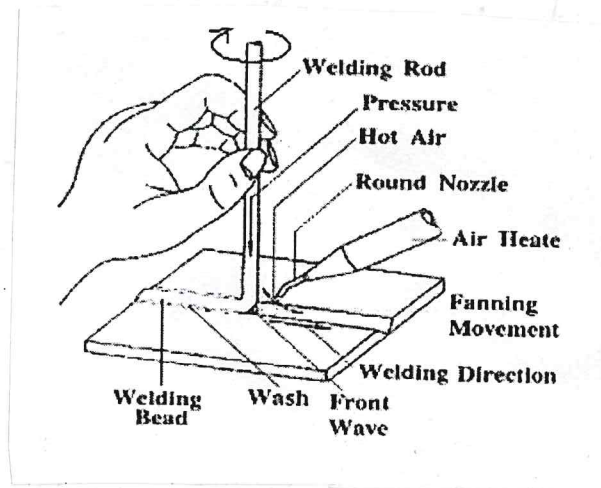

- Hot - pressure - welding is similar to both friction welding and flash welding - although the source, of heating is different.

- The surfaces should be machined square and cleaned for obtaining the best results.

- Some bevelling is used to control the amount of upset. The process can be performed by a manual operation.

- The materials to be welded must exhibit hot ductility or forge ability.

- Therefore, Cast iron cannot be hot pressure welded.

- The materials commonly joined by hot pressure welding are Carbon Steels, low alloy steels and certain non ferrous metals.

- Some dissimilar materials combinations are weld able by hot pressure welding.

- Materials that immediately form of the surface adherent oxides upon heating are highly challenging in air by this process.

- Aluminium alloys and Stainless steels are carried in a vacuum chamber.

- There are five cycles that hot pressure welding undergoes as follows.

1. Cycle 1: Load phase

2. Cycle 2: Melt phase

3. Cycle 3: Open phase

4. Cycle 4: Seal phase.

### Advantages:

1. Welding process is simple.
2. It needs simple joint preparation.
3. It is relatively low cost equipment.
4. It ensures quick weld production.
5. High quality joints are produced.
6. There is no filler metal needed.
7. Minimally skilled operators are required.

### Limitations:

1. Not all metals are weldable.
2. It is not easily automated.
3. Length of cycle is dependent on time

for heating.

4. Removal of flash and bulge are required after welding.

5. Only simple sections are readily  
butt weldable.

### Applications:

1. It is used in aerospace industry.
2. It is used in plastic welding.
3. It is used for producing medical devices.
4. It is used in ship building.
5. It is used in automotive industries.

1875

...

...



## UNIT - IV

### Other Welding Processes.

Thermit welding, Atomic hydrogen welding, Electron beam welding, Laser Beam welding, Friction stir welding, Under water welding, welding automation in aerospace, nuclear and surface transport vehicles.

#### Thermit Welding:

- Thermit or aluminothermic is the name given to a mixture of finely divided metal oxide and aluminium powder. It is a mixture of aluminium and iron oxide in the ratio of 1:3.
- Thermit welding is a welding process utilizing heat generated by exothermic chemical reaction between components of the Thermit.
- The molten metal produced by the reaction act as a filler material and joints the workpieces after solidification.
- The welding principle is the heat of the Thermit reaction used for welding in plastic state and mechanical pressure is applied for the joint.

• Thermit welding is a fusion welding process. In this process, neither arc is produced to heat parts nor flames are used.

• For getting high temperature, the exothermic reaction is used. To obtain exothermic reaction, the commonly utilizing composition of iron oxide red powder ( $\text{Fe}_3\text{O}_4$ ) with aluminium powder (Al) gives, aluminium oxide powder ( $\text{Al}_2\text{O}_3$ ) and iron (Fe).

• To beat the metal, it requires no external source of heat or current.

• The intense heat is released because of the chemical action not only melt the iron but also it raises the molten metal to a temperature of about  $2800^\circ\text{C}$ .

• Molten metal obtained by Thermit reaction is poured into the refractory cavity made around the joint.

• The aluminium oxide floats at top of the molten metal as a slag.

- The crucible is then tapped and the superheated metal runs around the parts to be welded which are contained in a mould.

- The high temperature of iron results in excellent fusion with the parts to be welded.

- Quality of welding is depending on the chemical reaction between iron oxide and aluminium.

- The reaction in Thermit welding is given by the following equation.

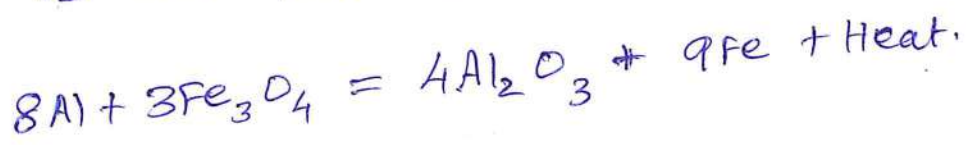

- This reaction takes place about 30 seconds only and the heat liberation temperature is about  $2800^\circ\text{C}$ .

- It is twice the melting temperature of steel.

- The ends which are to be welded are thoroughly cleaned of scale and rust so that there is a gap between them for the molten metal to penetrate well into the joint.

- If the parts are thick, the mould cavity may be preheated to improve welding and dry the mould. Other thermite mixtures are aluminium and copper oxide (for welding copper cables.)

- It is similar to a casting process.
- Figure illustrates the arrangement of various components of Thermite welding process.

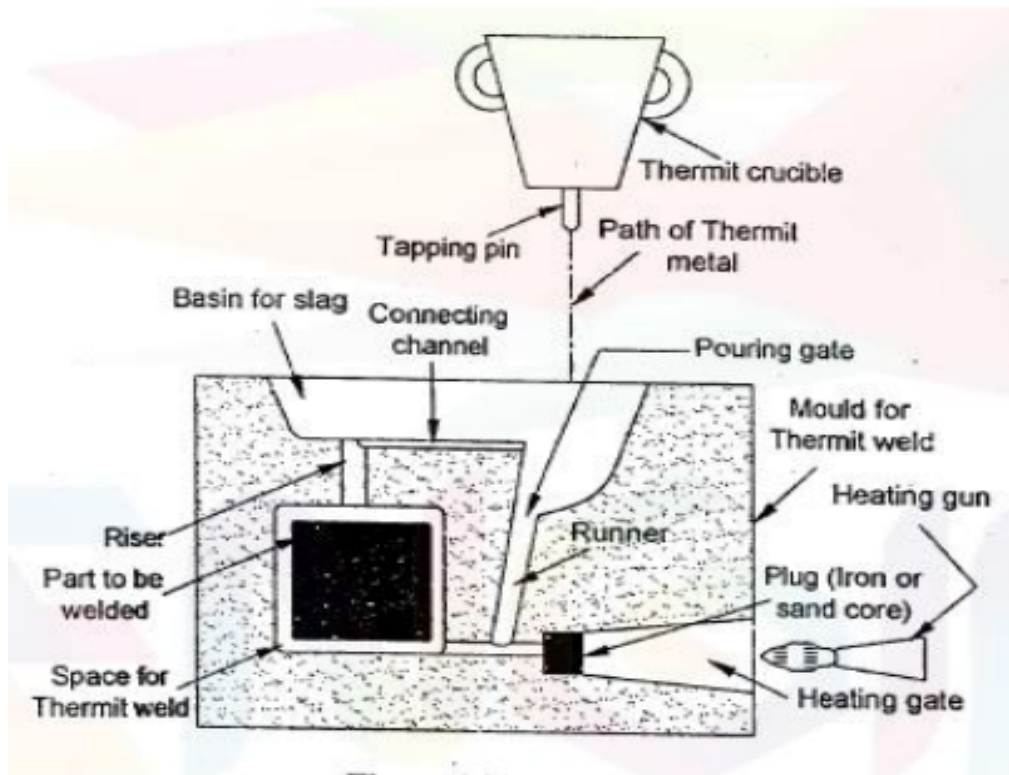

Figure 4.1 Thermite welding

## Mould Preparation :

The following steps are carried to prepare the mould for thermit weld.

1. Wax is poured in the joint and wax pattern is formed where the weld is to be obtained.
2. A moulding flask is kept around the joint and sand is rammed carefully around the wax pattern.
3. Pouring basin, sprue and riser are made.
4. A bottom opening, is provided to run off the molten wax.
5. The wax is melted through the opening at the bottom which is used to preheat the joint and make it ready for welding.
6. The igniting mixture (barium peroxide or magnesium) is placed at the top of the thermit mixture and is ignited by means of a heated rod or acetylene gas.
7. Complete reaction takes place and molten metal is produced.

8. Strength of Thermit welded joint is same as forged metal without any defects.

### Classification of Thermit welding:

Thermit welding processes is classified into the following two types:

1. Pressure welding Process.
2. Non pressure welding process.

#### 1. Pressure welding process:

- During pressure welding process, the parts to be welded are fitted and enclosed in a mould.
- The mould can be easily removed after welding the metals.
- First, the heated iron slag is poured to the mould and the aluminium oxide is poured on the parts to be welded.
- It will create the heating of parts and then the pressure is applied on the workpiece to join.

## 2. Non-Pressure Welding:

- In this process, the parts to be welded are lined up in parallel and a groove is taken in the parts.
- The wax pattern is formed in and around the welding parts.
- Then sand is rammed around the wax pattern and mould is completed with gate, runner and riser around the joint area.
- Then the mould is heated and wax is melted, it will give a space between joints.
- Finally, the heated Iron Slag and aluminium are poured into mould after solidification of liquid metal.
- Thus, the joint is made without the application of pressure.

### Operation of Thermit Welding:

- The edges of the workpiece are cut flat and cleaned to remove dirt, grease and other impurities to obtain a sound weld.

- A gap of about 1.5-6 mm is left between edges of the two workpieces.

- A wax heated to its plastic state is poured in the gap between workpieces to be joined and allowed to solidify. Excess wax solidified around the joint is removed.

- A mould box is placed around the joint and packed with sand providing necessary gates and risers.

- A hole or heating gate is made in the mould connecting to the joint.

- The wax material is melted out by means of a flame directed in to the heating gate so that it leaves a cavity at the joint which will later be occupied by the molten metal.

- The heating gate is then closed with a sand core or iron plug.

- Thermit is placed in a furnace and it is ignited.

- So, the chemical reaction takes place.



- Due to this, liquid and slag are formed.
- Exothermic reaction occurs to form molten iron and slag which floats at the top.
- The temperature resulting from this reaction is approximately  $2500^{\circ}\text{C}$ .
- The plug at the bottom of the Crucible is opened and the molten metal is poured into the cavity.
- The molten metal act as a filler metal, melts the edges of the joint and fuses to form a weld.
- After the weld joint cools and solidifies, the mould is broken, risers are cut and the joint is finished by machining and grinding.

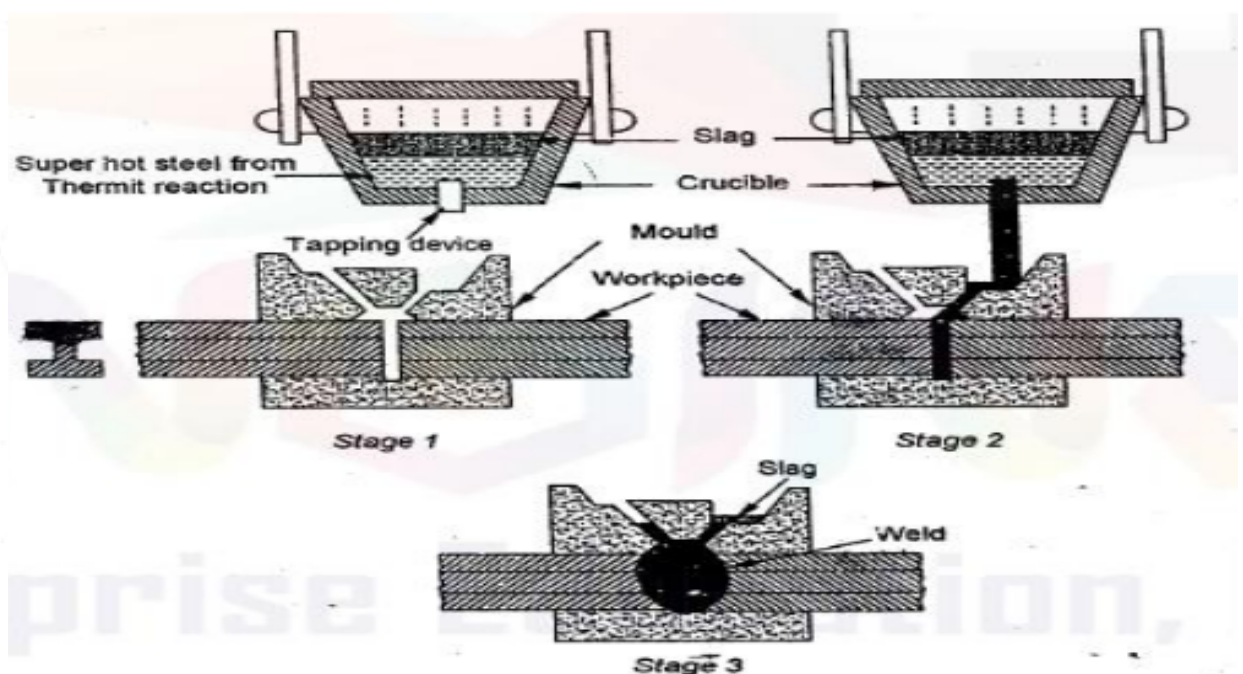

Various stages in Thermit welding are shown in figure.

1. Thermit is ignited.
2. Crucible is tapped, and superheated metal flows into mould.
3. Metal solidifies to produce weld joint.

### Advantages:

1. No external power source is required (Heat of chemical reaction is utilized).
2. Very large heavy section parts may be joined.
3. The process uses simple and inexpensive equipment.
4. The process is best suitable particularly in remote locations where sophisticated welding equipment and power supply cannot be arranged.
5. It can weld complex shapes.

### Limitations:

1. It is not possible for low melting points.
2. Only ferrous (steel, chromium, nickel) parts may be welded.
3. High skill operators are required.
4. Welding rate is slow.
5. It reduces the risks to operator.
6. Deposition rate is low.

7. High temperature process may cause distortions and it changes the grain structure in the weld region.

8. Weld may contain gas (Hydrogen) and Slag contaminations.

9. High level of fume occurs.

### Applications:

1. This process is used for welding of damaged wobblers and large broken crankshafts.

2. It is used in steel rolling mills.

3. It is used to restore the broken teeth on gears.

4. It is used to weld non-ferrous metals.

5. Joints in pipes, rails, shafts, are made in this process.

6. Automobile parts are welded by this process.

7. It is used in welding and repairs of large forgings, and broken castings.

8. It is used in welding of thick structural sections.

9. It is used in rail repairs and joining tracks on site.

10. It is used in welding cable conductors.

## Atomic Hydrogen Welding:

• Atomic Hydrogen welding (AHW) is a combination of electric arc and gas welding technique.

• It is a thermo-chemical arc welding process in which the workpieces are joined by heat obtained on passing a stream of hydrogen through an electric arc struck between two tungsten electrodes.

• The arc supplies the energy for a chemical reaction to take place.

• During the process, more heat is released due to exothermic reaction.

• The electric arc efficiently breaks up the hydrogen molecules which recombine with tremendous release of heat with the temperature from  $3400$  to  $4000^{\circ}\text{C}$ .

• Without the arc, an oxy-hydrogen torch can only reach  $2800^{\circ}\text{C}$ .

• An acetylene torch merely reaches  $3300^{\circ}\text{C}$ .

• It is the third hottest flame after dicyanoacetylene at  $4987^{\circ}\text{C}$  and cyanogen at  $4525^{\circ}\text{C}$ .

• This device is called an atomic hydrogen torch or nascent hydrogen torch or Langmuir torch.

• The process was also known as arc-atom welding.

• Filler rod may or may not be used during welding process.

• The heat produced by this torch is sufficient to weld tungsten ( $3422^{\circ}\text{C}$ ) and most of the refractory metal.

• Hydrogen gas acts as a heating element as well as it acts as shielded gas to protect the molten liquid metal from oxidation and contamination by carbon, nitrogen or oxygen which can severely damage the properties of many metals.

• It eliminates the need of flux for this purpose.

• The arc is independently maintained for the workpiece or parts being welded.

• The hydrogen gas is normally diatomic ( $\text{H}_2$ ) but where the temperatures are over  $6000^{\circ}\text{C}$  near the arc.

• When the hydrogen strikes a relatively cold surface, it will recombine into its diatomic form releasing the energy associated with the formation of bond.

- The energy in AHW can easily be varied by changing the distance between arc stream and workpiece surface.

- This process is being replaced by gas metal-arc welding mainly because of the availability of inexpensive inert gases.

- In this process, arc is maintained entirely independent of the work of parts being welded.

- The work is a part of the electrical circuits only to the extent that a portion of the arc comes in contact with the work at which time a voltage exists between work and each electrode.

- It differs from shielded metal arc welding in which the arc is independent of base metal making electrode holder as a mobile without arc getting extinguished.

- Thus, heat input to the weld could be controlled by manually to control welds metal properties.

- This process has the following special features:

- High heat concentrations is obtained
- Hydrogen acts as a shield against oxidation.

- Filler metal of base composition could be used.
- Most of its applications can be met by MIG process.
- Therefore, it is not commonly used.

### Working of Atomic Hydrogen welding:

• The equipment consists of a welding torch with two tungsten electrodes inclined and adjusted to maintain a stable arc as shown in figure.

• Annular nozzles around the tungsten electrodes carry the hydrogen gas supplied from gas cylinders. AC power source is suitable as compared to DC because equal amount of heat will be available at both electrodes.

• A transformer with an open circuit voltage of 300 V is required to strike and maintain the arc.

• The workpieces are cleaned to remove dirt, oxides and other impurities to obtain a sound weld. Hydrogen gas supply and welding current are switched ON.

• An arc is struck by bringing two tungsten electrodes in contact with each other and instantaneously separated by small distance of 1.5 mm.

• Therefore, the arc still remains between two electrodes.

• As the jet of hydrogen gas is passed through the electric arc, it dissociates into atomic hydrogen by absorbing large amounts of heat supplied by electric arc.

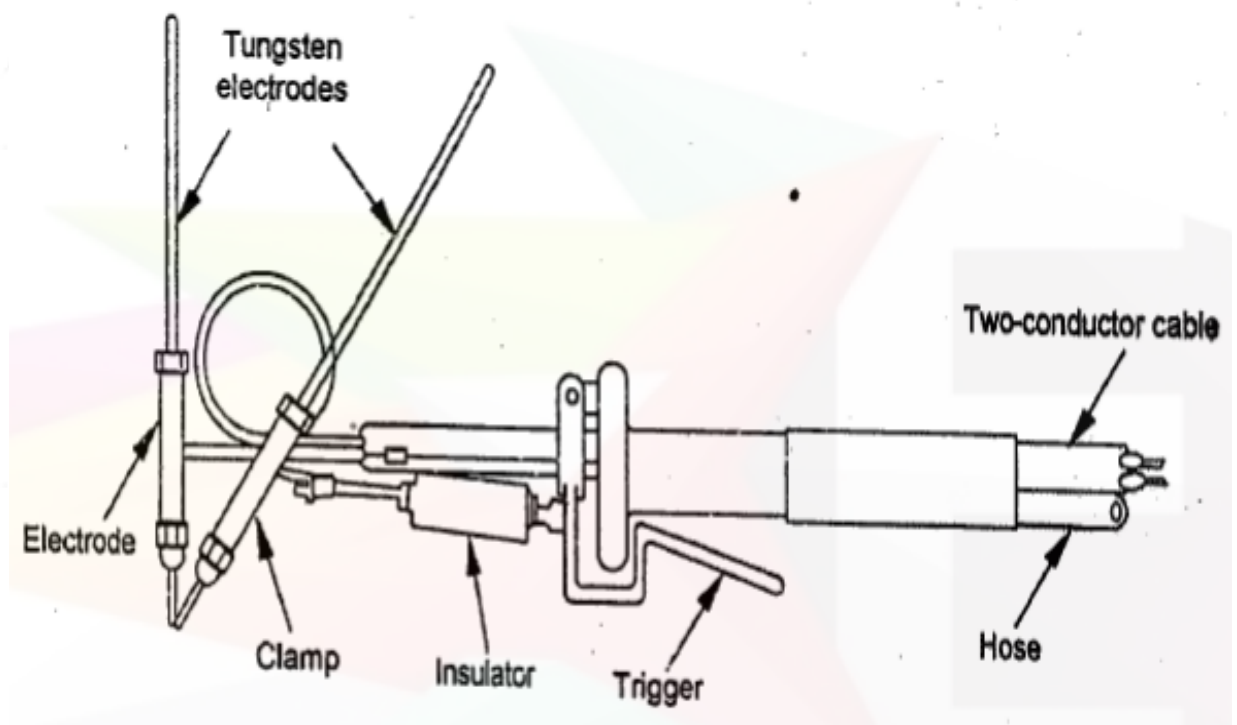



• Thus, the heat absorbed can be released by recombination of hydrogen atoms into hydrogen molecule ( $H_2$ ).

• Recombination takes place as the atomic hydrogen torches the cold workpiece liberating a large amount of heat.

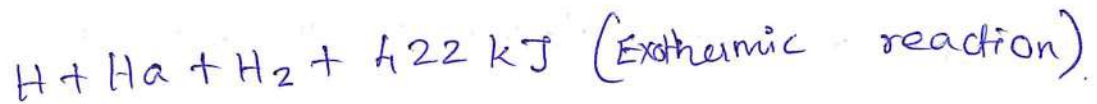

## Advantages, Limitations and Applications of Atomic

### Hydrogen Welding:

#### Advantages:

1. Welding process is faster.
2. During the process, intense flame is obtained which can be concentrated at the joint. Hence, less distortion occurs.
3. The separate flux and shielding gas or flux. The hydrogen envelop itself prevents oxidation of the metal and tungsten electrode. It also reduces the risk of nitrogen pick-up.

4. Workpiece do not form a part of the electric circuit. Hence, problems such as striking the arc and maintaining the arc column are eliminated.

5. Welding of thin materials is also possible which may not be successfully carried out by metallic arc welding.

6. The workpiece does not form a part of the electrical circuit. The arc remains between two tungsten electrodes and it can be moved to other places easily without getting extinguished.

### Limitations:

1. The cost of welding is high when compared to the other process.

2. Welding process is limited to flat positions only.

3. The process cannot be used for depositing large quantities of metals.

4. Welding speed is less when compared to metallic arc or MIG welding.

### Applications:

1. These welding processes are used in welding of tool steels which contain tungsten, nickel, and molybdenum.

2. They are used in joining parts, hard surfacing and repairing of dies and tools.

3. Atomic hydrogen welding is used where repaired welding is necessary in stainless steels, non-ferrous metals and other special alloys.

### Electron Beam Welding (EBM)

• Electron Beam welding (EBM) is a fusion welding process in which a beam of high velocity electrons is used for producing high temperatures and melting the workpiece to be welded.

• The electrons strike the workpiece and their kinetic energy is converted into thermal energy by releasing heat which is used to heat the metal so that the edges of workpiece are fused and joined together forming a weld.

### Working principle:

• If a filament of tungsten or tantalum is heated to high temperature in a vacuum either directly by means of an electric current or indirectly by means of an adjacent heater, a great number of electrons are given off from the filament.

- These electrons carry a negative charge which is passed through the anode hole.

- The greater is the filament current, the higher will be the temperature and greater will be the electron emission.

- If a metal disc with a central hole is placed near the filament and charged to a high positive potential relative to the filament, the emitted electrons are attracted to the disc because of their kinetic energy pass through the hole as a divergent beam.

- So, the filament is the cathode and the disc is the anode.

- The electron beam is focused by the focusing lens.

- The focus is done electrostatically or magnetically by means of coils situated adjacent to the beam and through which a current is passed.

- The beam is now convergent and it can be spot focused.

- The basic arrangement of an electron 'gun' is done which is similar to television tubes and electron microscopes.

- When the focused electron beam strikes the work piece, the kinetic energy of this electron beam is converted into heat energy.

• This heat energy is used to weld the metals. The kinetic energy of an electron is  $mv^2$  where  $m$  is the mass of an electron ( $9.1 \times 10^{-31}$ ),  $v$  is the velocity.

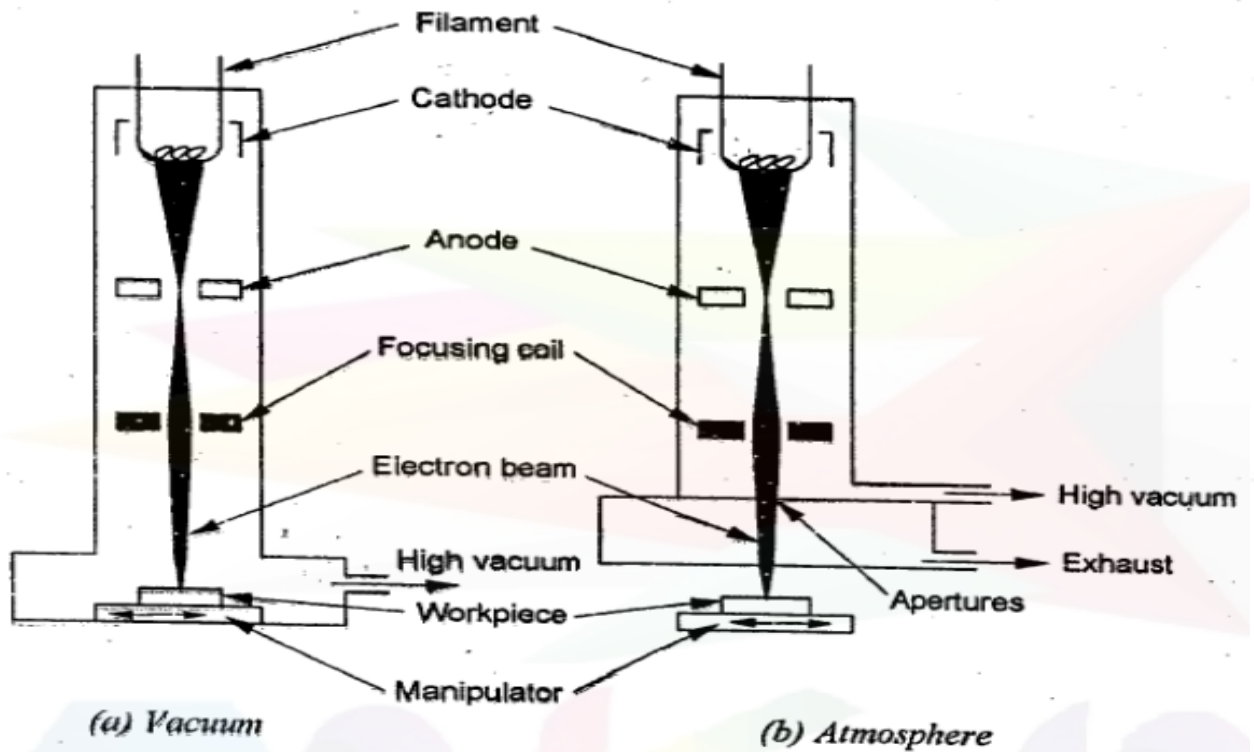

• The electron mass  $m$  is small but increasing the emission from the filament by raising the filament current increases the number of electrons and hence, it produces the mass effect because the kinematic energy varies directly as the square of the velocity, accelerating the electrons up to velocities comparable with the velocity of light by using anode voltages (upto 200), greatly increases the beam energy.

- The smaller the spot into which the beam is focused, greater will be the energy density.

- So, it is possible to weld holes.

- The beams are focused about 0.25 mm to 1 mm diameter and the power density is of 10 kW/mm. Aluminium material has focusing length of about 40 mm and steel has about 30 mm.

- Accelerating voltage is in the range of 20 - 200 kV and welding current is about a few milli amperes. As the accelerating voltage is increased, the intensity of X-rays emitted from anode increases. Focusing coils can concentrate the beam on a spot of a few microns in diameter.

- With this concentrated spot, there is a threshold voltage angle which the beam penetrates the metal and when the work is traversed - relative to the beam.

- A weld bead of NAFTA width relative to the plate thickness is formed.

- When the beam strikes a metal surface X-rays are generated, adequate precautions must be taken for screening personnel from rays.

- If the beam emerges in ~~the~~ the atmosphere, energy is reduced by collision of electrons with atmospheric molecules and focus is impaired.

- Hence the operation is carried out in vacuum.

- The vacuum may be created either in the gun chamber or in a separate steel component chamber fixed to the gun chamber.

- Welding is non-vacuum atmospheric conditions requires much greater power than the vacuum method because of the effects of the atmosphere on the beam and greater distance from gun to work.

- A shielding gas may be required around the weld area.

- Welds made with this process on thicker sections are narrow with deep penetration with minimum thermal disturbance.

- At present, welds are performed in titanium, niobium, tungsten, tantalum, beryllium, nickel alloys (e.g. nimonic), Inconel, aluminium alloys and magnesium, mostly in the air and space research industries.

• The variables which are controlled in the electron beam welding are as follows.

1. Voltage,

2. Speed,

3. Distance between the beam gun

and workpiece.

## Advantages, Limitations and Applications of EBW

disadvantages :

Advantages :

1. High quality weld is produced.
2. Deep welding is possible.
3. Clean and bright weld can be obtained.
4. High speed operation can be achieved.
5. Dimensional accuracy is good.
6. Energy loss is very less.
7. Very small part can be welded.
8. There is no need of using electrodes.
9. High-quality welds, deep and narrow profiles are produced.
10. It has limited heat affected Zone and low thermal distortion.



11. Accurate control over welding conditions is possible by control of electron emission and beam focus.
12. No flux or shielding gases is needed.
13. Filler metal is not required.
14. Because of the vacuum conditions, it is possible to weld more reactive metal successfully.
15. This type of weld is more suitable for welding dissimilar materials.
16. Tight continuous weld can be produced.

### Limitations:

1. The welding cost is high.
2. Skilled persons are required.
3. It is limited to small size welding.
4. Welding should be carried out in vacuum seal only.
5. It is a time consuming process.
6. The weld suffers from contamination if it is performed in atmospheric condition.
7. Precise joint preparation and alignment are required.
8. X-ray irradiation occurs.
9. As EBW generates X-rays there must be protection against radiation hazards.

## Applications:

1. Dissimilar metals can be welded.
2. Refractory and reacting metals can be welded.
3. It is used in aircrafts, missile, nuclear component, gears and shafts.
4. It is suitable for large scale.
5. It is used in cars.

## Laser Beam Welding (LBM)

- The word laser stands for Light Amplification by the Stimulated Emission of Radiation. (LASER).
- It is stronger coherent monochromatic beam of light which can be highly concentrated with a very small beam divergence.
- The focused laser beam has the highest energy concentration of any known source of energy.
- The laser beam is a source of electromagnetic energy or light that can be projected without diverging and it can be concentrated to a precise spot.
- The beam is coherent which is of a single frequency.

- The coherent light emitted by the laser can be focused and reflected in the same way as a light beam.

- The focused spot size is controlled by a choice of lenses and the distance from it to the base metal. The spot can be made as small as 0.076 mm to large areas 10 times as big.

- A sharply focused spot is used for welding and cutting operations.

- The large spot is used for heat treating.

- Laser welding is suitable for welding deep in narrow joints with depth-to-width ratio ranging from 4 to 10.

- Laser beam welding (LBW) is a welding process which produces coalescence of materials with the heat obtained from the application of a concentrated coherent light beam impinging upon the surfaces to be joined.

- It is non-contact process that requires access to the weld zone from one side of the parts being welded.

- It is also thermoelectric process accomplished by material evaporation and melting.

- Laser-beam welding (LBW) utilizes a laser beam as the heat source.
- Light energy is converted into heat energy.
- Here, the light energy is produced from the laser source such as ruby rod in the form of monochromatic light: If the heat can be focused into small area, it has high energy for deep penetrating capability.
- Beam focusing is achieved by various lens arrangements because this focusing ensures high density which can be achieved by laser beam. LBW does not require a vacuum chamber.
- So, Heat Affected Zone (HAZ) is smaller and thermal damage to the adjacent part is negligible.

### Working Principle:

- The working principle of a laser welder is shown in figure.
- An intense green light is made to fall on a special man-made ruby of 10mm in diameter having 0.05% by weight of aluminium oxide.
- The green light pumps the chromium atoms to a higher state of energy.

- Each excited atoms emits red light which is in phase with colliding red light wave.
- The red light gets continuously amplified.
- The parallel ends of the rod are mirrored to enhance and bounce the red light back and forth within the run.

- After reaching the critical intensity, the chain reaction of collisions becomes strong enough to cause a burst of red light.

- The mirror at the front of the rod is only a partial reflector which allows the burst of light to escape through it.

- Due to electrical discharge from capacitors, the flash tube converts the electrical energy into light flashes.

- When ruby rod is exposed to intense light flash, the chromium atoms of crystal excited and pumped to a high energy level beam.

- This high energy level is immediately reduced to intermediate and dropped to original state with the evolution of red fluorescent light.

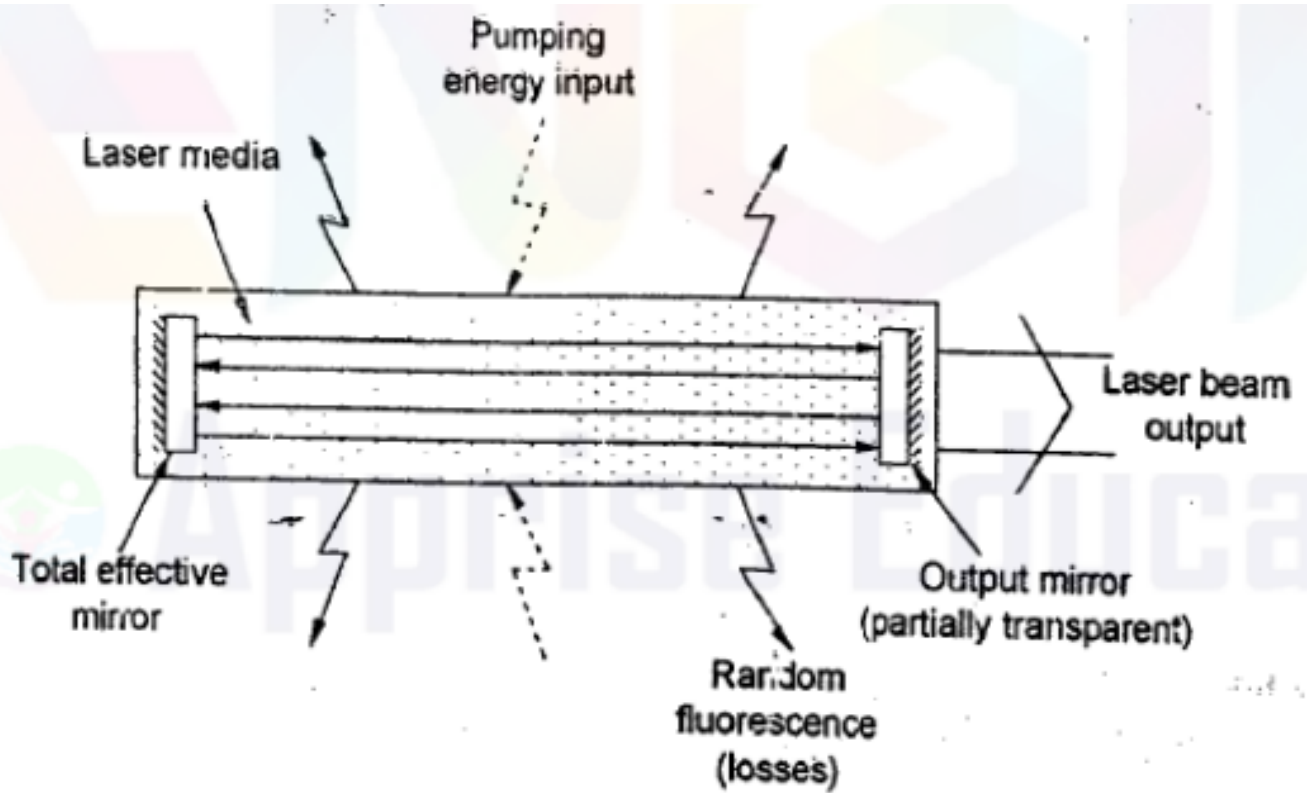

- The laser light is not only intense but also can be readily focused without loss of intensity.

- The laser light is focused by the focusing lens to the workpiece in the form of coherent monochromatic light as shown in figure.

- When this light energy is impacted to the workpiece, it will convert into heat energy. This heat energy is sufficient to melt the materials to be welded.

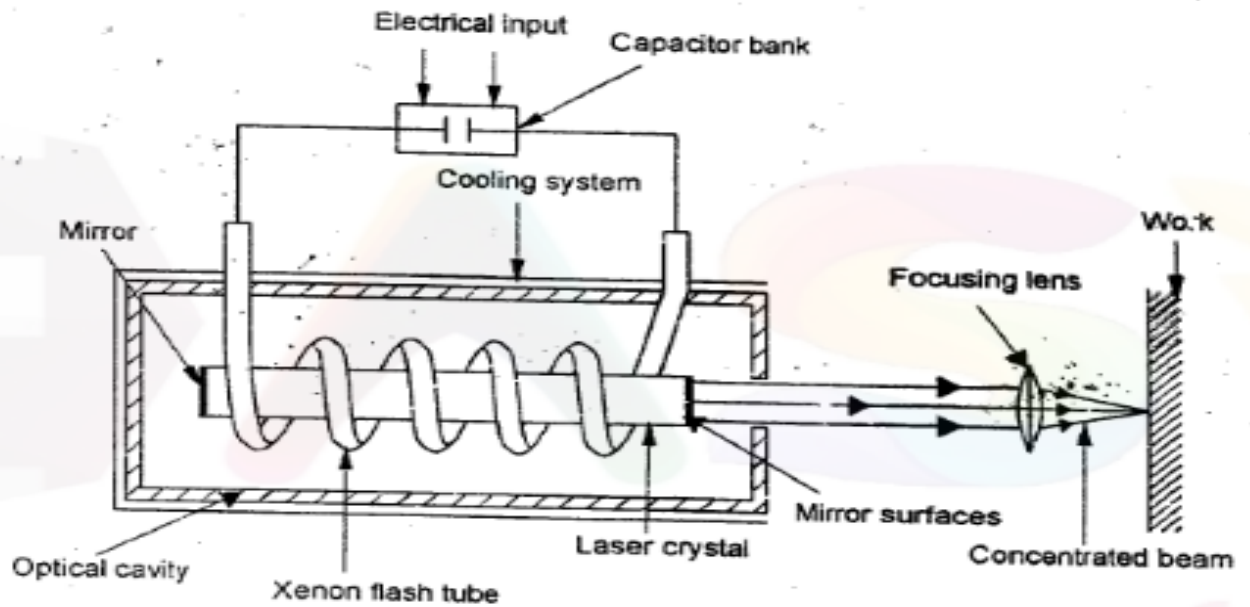

The schematic of laser beam welding is shown in Figure 4.8 below.

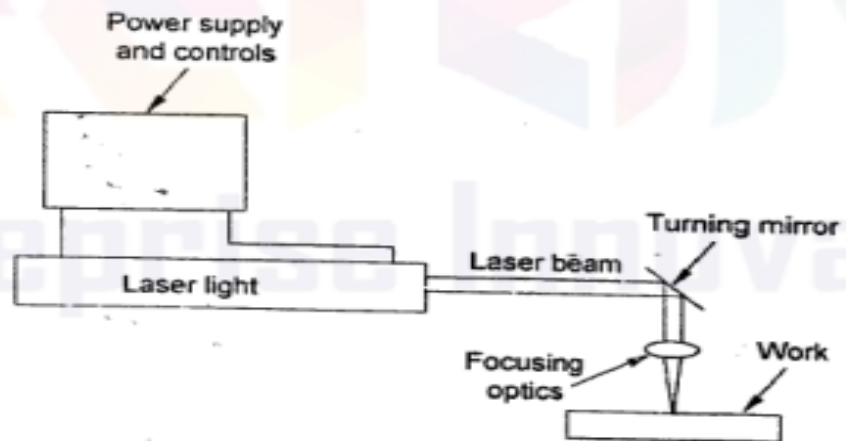

### Advantages:

1. There is no need of electrodes and power.
2. Even very small holes can also be welded.
3. There is no vacuum requirement such as electron beam.
4. Accuracy is greater.
5. There is no heat loss.

6. Neat and clean surface finish can be obtained.

7. Laser beam welding can be used to weld dissimilar metals which are difficult to weld.

8. X-rays are not generated by the beam and hence it is safe.

9. Laser beam can be manipulated using the principles of optics to permit easy automation.

10. Cooling rates are high due to low energy inputs per unit weld length. Also, the problems associate with welding can be rectified by pre- or - post - heat treatment processes.

11. Ruby lasers are used for spot welding of thin gauge metals.

12. Electrical efficiency of the process is 10-20% only.

13. Better quality weld can be produced.

It produces fewer tendencies for incomplete fusion, spatter, porosity and distortion.

14. It ensures precise working with exact placing of the energy spot welding of complicated joint geometry.

15. It produces low thermal distortion.



16. It produces cavity-free welds.
17. It needs low post weld operation times.
18. Large working distances is possible.
19. No filler metals are necessary.
20. Works with high alloy metals without difficulty.

### Limitations :

1. Welding process is slow.
2. Limited depth of weld can be done.
3. It is not suitable for large production.
4. Capital cost for equipment is high.
5. Optical surfaces of the laser are easily damaged.
6. Maintenance cost is high.
7. Rapid cooling rate may cause cracking in some metals.

### Applications :

1. Thin metals about 0.5 mm to 1.5 mm thick can be welded, It includes welding of foils, stents, sensor diaphragms and surgical instruments.
2. It can joint dissimilar metals such as copper, nickel, chromium, stainless steel, titanium and columbium.
3. It is very much useful in electronic components welding.

4. It is used in aircraft components joining.
5. In automotive industry, it is mostly used for welding transmission components.
6. It is very much useful in joining metal alloy.
7. Laser beam welding of high strength aluminium alloys is used for aerospace and automotive applications.
8. With slight modification the process can be used for gas-assisted cutting and surface heat treating and alloying applications.

### Welding Automation in Nuclear Sector:

- Most nuclear reactors have restricted physical access to pipe work so a remote automated weld head is far safer and more accurate than a manual system.
- Additionally, in nuclear applications, weld integrity and ability to adapt to exotic materials are critical.
- The accuracy and consistently high quality welds achieved by the automated weld head, power sources and control systems are now essential to the nuclear industry.
- Automated orbital welding technology was first established in 1976 and its welding systems

now provide a range of applications for the nuclear industry from secure seals on 3013 high level waste containers to precision welding for reactor tube sheets, turbine shafts, and reactor piping vessel maintenance and repair and superheated steam generator piping.

### Narrow gap Welding Process:

- The conventional welding technique such as shield metal arc welding has been mostly applied to the piping system of the nuclear power plants.
- This welding technique causes the overheating and welding defects due to the large groove angle of weld.
- On the other hand, the Narrow Gap Welding (NGW) technique has many merits such as reduction of welding time, shrinkage of weld, small deformation of the weld due to the small groove angle and welding bead width as compared to the conventional welds.
- Narrow gap welding allows the butt joining of very thick components while limiting welding time and residual deformations.

- Narrow gap welding is broadly used in nuclear industry for the fabrication of reactor vessels, steam generators and pressurizers.

- It is also used in pressure vessel, boiler and heavy machinery industry.

- Specific welding machines have been designed for various technologies used in narrow gap welding such as submerged arc welding, TIG and MIG processes.

- Other narrow gap welding technologies involving lasers are being developed.

- The narrow gap welding process is designed to meet the quality, mechanical properties and overall cost requirements of heavy wall fabrication.

- It is a submerged arc process designed to weld thick walled steel which uses a narrow gap plate preparation.

- The process is appropriate for both flat and circumferential welding.

- A multi-layer technique is recommended in place of one large pass per layer.

- It minimizes undercut, trapped or mechanically locked slag and concave weld profiles.

- The narrow gap process produces a multi-layer weld with uniform side wall penetration, maintaining low parent metal dilution and low heat input.

- Narrow gap processes are made possible by several new submerged arc flux/electrode combinations and a specially designed deep groove nozzle assembly.

- Only the recommended flux/electrode combinations should be used.

- When properly selected electrodes are used to meet the job requirements, these flux/electrode combinations will deliver excellent welding characteristics and mechanical properties.

- When following the recommended procedures, very good bead shape and self-releasing slag will result.

- The narrow gap process results in lower welding cost by reducing the volume of weld metal required for heavy plate thicknesses.

- The Cost of Consumables, welding time and preparation time is also reduced when compared to more conventional methods.

- Industry applications of narrow gap welding process.

1. Steam generators of power plant.
2. Petrochemical industries.
3. Shipbuilding
4. Heavy machinery fabrication.
5. Nuclear reactor vessel manufacturing.

- Benefits :

1. Minimum joint preparation and minimum joint volume.
2. Good mechanical properties.
3. Low heat input.
4. Low parent metal dilution and small heat affected zone.
5. High quality weld can be produced without turning plate.
6. Simple " off - the - shelf " equipment solution.
7. Low distortion.

## Turn - key - welding Solutions :

- Reliable operation and integrity of nuclear pressure equipment are of great importance for the safety of nuclear facilities.

- Precision motion for welding operations is essential to ensure consistent and reliable operation.

- Non-precision motion can cause inconsistent welds which may lead to premature component failure by resulting in facility damages, expensive component replacement/rework and losses in productivity.

- Quality assurance measures should be built into an automated welding system to verify welds which are performed within the system's programmed welding parameters.

- If no in process quality assurance measures are used, then small but potentially numerous variations may pass undetected during welding operations thereby resulting in a faulty or less than ideal part.

- Safety is main concern in the nuclear industry. Great measures are taken to establish and maintain high standards to protect employees and operators.

• Turn-key welding solutions which are designed for nuclear applications offer variety of benefits

• It is easy-to-use interface and precise controls provide a complete solution for even most high tolerance applications.

• This welding system is used for critical applications in the nuclear industry.

• Turn-key TIG process has been used globally as a solution to complex welding applications and strict nuclear code requirements.

• Turnkey welding solution controls include encoder-based servo motor driven axes for precise and repeatable motion.

• This level of precision ensures that parts will be welded consistently and reliably.

• Controller of turn-key welding is configurable with data acquisition and tolerance checking software. The software collects data for each axis of motion as well as each welding parameter.

• If any of the parameters is out of the tolerance range, then the program is



automatically terminated. Controller is designed for operation either at the weld zone or in safe environment remotely.

- The operator has complete control in either location which is essential for the nuclear industry.

- The nuclear world of welding brings many complex alloys into consideration such as the many variations of stainless steel, chrome and nickel alloys used in both commercial and military projects throughout the world.

- So, automated welding improves safety and productivity in nuclear industry.

### Welding automation in Surface Transport Vehicles:

- Welding is automotive industry.

- Resistance welding in the automotive industry is probably the most common.

- During vehicle assembly, there are three resistance welding processes such as spot welding, projection welding and seam welding mostly used.

- Projection welding in automotive industry is utilized for the fastening of screw machine parts to metal ending studs and nuts. It is also used to join wires and bars that must be crossed.

- Spot welding is utilized for joining sheet metal parts to a vehicle.
- Resistance spot welding is particularly advantageous in the automotive industry due to its ability to provide rapid, high volume manufacturing, operational ease, safety, low environmental impact, cost efficiency as well as stable and repeatable results.

- Resistance seam welding is utilized as a part of the automotive after treatment system. MIG welding machines are usually employed for this process.

- Two primary design considerations for resistance seam welding in the automotive industry include porosity probability and finished weld surface condition requirements.

### Body welding:

- The manufacture of a car is done in three stages such as.

- Body construction.
- Surface treatment (Surface painting)
- Vehicle assembly.

- The galvanized steel panels for the body shell which are first welded together. It was a pure labour intensive process because it was done manually.

- So, this welding was mainly depending on the skill of the welder. In a modern car assembly plant, robots perform this task on the body and welds.

- So, the process is highly automated which produces homogenous and high quality weld. Simultaneously, it saves the labour cost.

- The galvanized steel panels for the body shell which are first welded together.

- It was a pure labour - intensive process because it was done manually.

- So, this welding was mainly depending on the skill of the welder.

- In a modern car assembly plant, robots perform this task on the body and welds.

- So, the process is highly automated which produces homogenous and high quality weld. Simultaneously, it saves the labour cost.

## Welding in railway industry:

- Resistance welding in the railway industry is advantageous due to its ability to provide high structural integrity, aesthetic qualities and high productivity.

- Resistance welding is used throughout the process of railway car fabrication.

- It is also used for joining railway rails as well as joining different materials in railway switches.

- Most modern railways use Continuous Welded Rail (CWR) which is also referred to as ribbon rails.

- In this form of track, the rails are welded together by utilising flash butt welding to form one continuous rails that may be for several kilometers long.

- Welded rails are more expensive to lay than jointed tracks but they have much lower maintenance costs.

- The preferred process of flash butt welding involves an automated track-laying machine running a strong electrical current through the touching ends of two pieces of rails to be joined.

- The ends become white hot due to electrical resistance and they are then pressed together forming a strong weld.

- Thermit welding is used to repair or splice together existing CWR segments in remote areas.

- It is a manual process requiring a reaction crucible and form to contain the molten iron.

- Joints are used in continuous welded rail when necessary, usually for signal circuit gaps.

- Instead of a joint that passes straight across the rail, two rail ends are cut at an angle to give a smoother transition.

- In extreme cases, such as at the end of long bridges, a breather switch next rail, gives a smooth path for the wheels while allowing the end of one rail to expand relative to the

- Robot welding is the use of mechanized programmable tools (robots) which completely automate a welding process by both performing the weld and handling the part.

- Processes such as gas metal arc welding while often automated are not necessarily equivalent to robot welding since a human operator sometimes prepares the materials to be welded.

- Robot welding is commonly used for resistance spot welding and arc welding in high production applications such as automotive industry.

- Robot arc welding is growing quickly just recently and it guarantees about 20% of industrial robot applications.

- The major components of arc welding robots are the manipulator or the mechanical unit and the controller which acts as the robot's "brain".

- The robot may weld a pre-programmed position be guided by machine vision or by a combination of two methods.

## UNIT - V

### Weld Joints :

- Welded joints are classified according to the relative position of two components to be joined.
- There are five basic types of welded joints.

### Butt Joint :

- It is used to join the ends or edges of two plates as shown in figure.
- The surface of plates is located in the same plane.
- The edges of the plates are bevelled depending on their thickness.
- Table indicates the thickness of plates for which different types of butt joints are used.

Types of joints	Thickness of plates (mm)
Square butt joint	1-6
Single V butt joint	6-20
Double V butt joint	12 - 60
Single U butt joint	20-60
Double U butt joint	30-60

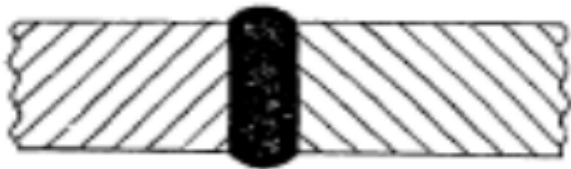

(a) Square butt joint



(b) Single V- butt joint

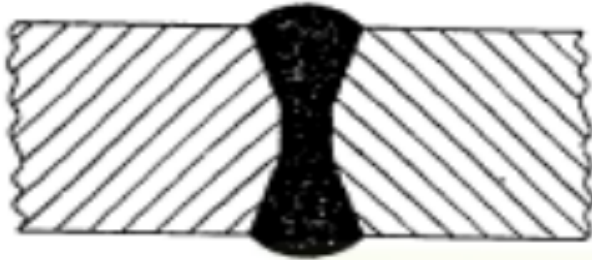

(c) Double V- butt joint



(d) Single U- butt joint



(e) Double U- butt joint

### Types of butt welded joints

#### Lab joints :

- In a lap joints, the two plates are overlapped each other for a certain distance.
- Then the edge plate is welded to the surface of the other surface as shown in figure. Such a weld is also called fillet weld.

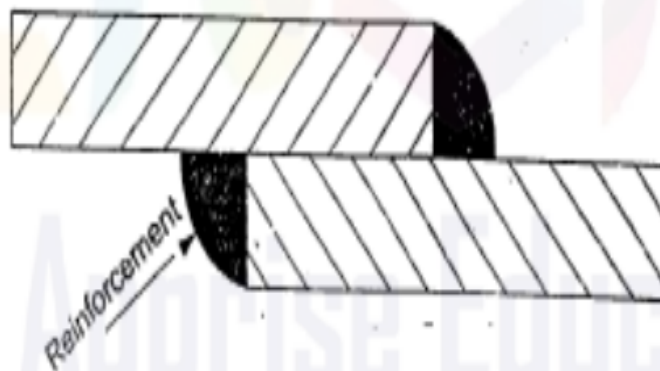



- A fillet weld consists of approximately triangular cross section joining two surfaces at right angle to each other.

- Sometimes, it may also be reinforced to increase the load capacity of the weld per unit length as shown in figure.

### Tee joint:

- The two plates are arranged in "T" shape. Located at right angle to each other and the overlapping edges are welded by fillet weld as shown in figure.

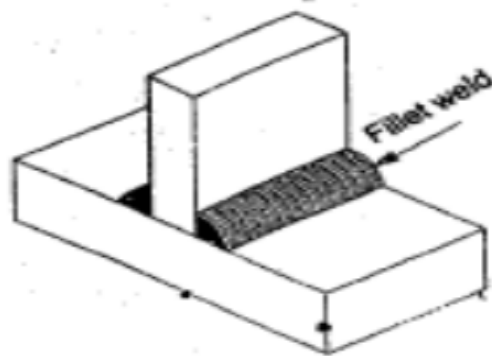

### corner joint:

- In this type of joint, two plates are arranged at right angle in such a manner that it forms an angle. L shape as shown in figure.

• The adjacent edges are joined by a fillet weld.







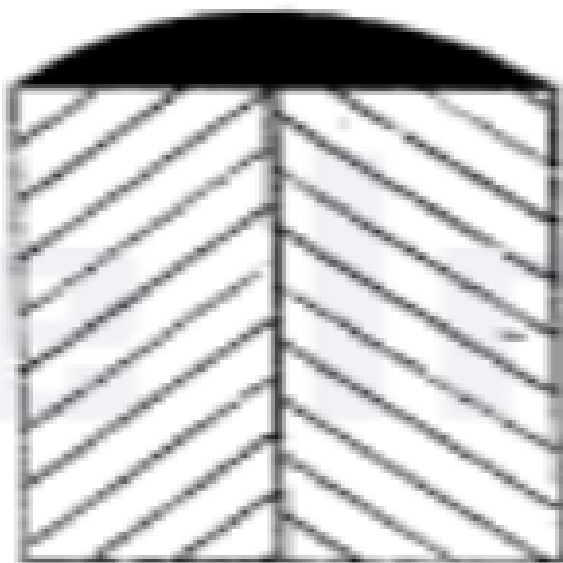















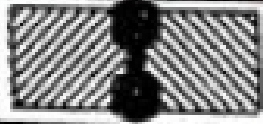

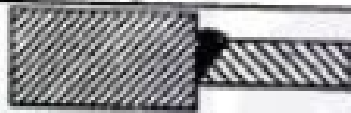

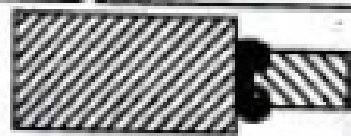

Edge joint:

• For a plate of thickness less than 6 mm, the ends of the overlapping plates can be directly welded at the edges as in figure. Such joints are called edge joint.



# Basic Weld Symbols:

Table 5.2 Basic weld symbols

S.No	Name of joint	Joint	Symbol
1	Fillet		
2	Square butt		
3	Single V- butt		
4	Double V- butt		
5	Single U- butt		
6	Double U- butt		
7	Single bevel butt		
8	Double bevel butt		
9	Single-J butt		
10	Double-J butt		
11	Spot		
12	Sealing run		
13	Bead (Edge or seal)		

Source: *Welding Handbook, American Welding Society, 1950*

## Weldability of Stainless Steels:

- The most popular welding process used on stainless steels is Gas Tungsten Arc welding (GTAW or TIG).

- It is the most widely used process due to its versatility, high quality and aesthetic appearance of the finished weld.

- Pure argon is the most popular shielding gas but argon rich mixtures with the addition of hydrogen, helium or nitrogen are also employed for specific purposes.

- Plasma Arc Welding (PAW) is also used to weld stainless steel.

- It is mainly used in a mechanised system where high speeds and high productivity autogenous welding of square edges butt joints are needed.

- PAW root weld is followed by multi-pass joint filling.

- Argon backing gas protection is necessary to maintain the corrosion resistance of the under bead.

- Shielded Metal Arc Welding (SMAW or MMA) is the oldest of the arc processes.

- The most widely used, acid retile coated electrodes produce a spray arc type metal transfer, self releasing slag and a finely ripple aesthetic weld profile.

- They are primarily used in the down hand position when producing fillet and butt welds.

- Electrodes with this coating type can be used in position but they are limited in application and size.

- Gas Metal Arc Welding (GMAW or MIG)

is the semi automatic welding process which can be used manually or automated.

- It is employed for its high productivity features when welding thin material using short-circuit metal transfer mode or spray arc transfer with thicker material.

- Gas mixtures with the addition of oxygen, helium, carbon dioxide, etc. are to improve the arc stability and weld bead 'welding characteristics'.

- Flux Cored Arc Welding (FCAW or FCW) produces higher rates of weld deposition and weld metal overlaying are possible.

- significant reduction in post weld cleaning weld dressing is possible.

• Submerged Arc Welding (SAW) is a fully mechanised wire and flux powder shielded arc process Capable of high deposition rate, fast travel speed and weld quality.

• It is used in continuous down hand fillet and butt welds in thicker section plate, pipe and vessels and also stainless steel cladding of mild steel components, particularly where long seams or extended runs are involved.

• Electric Resistance welding (ERW) method of resistance spot and seam welding is used in mass production welding of thinner stainless steel material where the overlap joint type of weld configuration is required.

• Laser welding is very intense and it is Capable of producing deep penetration weld in thick section stainless steel with minimal component distortion.

• The process employs high capital cost equipment and its use is reserved for mass production manufacturing.

## General Guidelines to Weld Stainless Steel Parts :

1. Excessive heat input and high weld inter-pass temperature should be avoided to reduce high coefficient to thermal expansion and low conductivity. Otherwise, high heat input will result excessive distortion and residual stress.

2. Design criteria and metallurgical transformation due to welding may necessitate the selection of a non-matching welding consumable to achieve toughness levels at cryogenic temperatures or increased weld metal corrosion resistance.

3. It is important to reserve a fabrication facility exclusively for stainless steel whenever possible. In addition, protective handling equipment and tools should be used which are dedicated to stainless steel fabrication to avoid contamination from contact with carbon steels.

4. The consultation of the parent material or welding consumable supplier manufacturer is recommended.

5. When shielding gas is required for updated information or recommended gas compositions, the supplier should be consulted by the person who takes welding.

6. When new grades of materials are to be welded, especially ferrite, martensitic and duplex alloys, for weld procedure information and filler material recommendations, manufacturer should be consulted.

7. Post weld dressing is done by using pickling pasters or other corrosive substances.

### Defects in Welding:

- A welding defect is any flaw that compromises the usefulness of a weldment.

- The improper welding parameters, base metal and selection method introduce defects in the weld metal.

- So, the defective weld causes failure in live conditions and damages to the properties the defects in weld depending on thickness, load, environment and size of the weld.

- The major defects which are causing in the weld are:

1. Lack of fusion

2. Lack of root penetration.

3. Cracks,

4. Cavity

5. Porosity

6. Undercut



7. Distortion.
8. Slag inclusion
9. Lamellar tearing
10. Overlapping
11. Imperfect shape or unacceptable contour.
12. Miscellaneous defects.

#### 4. Lack of fusion:

- Lack of fusion is the poor adhesion of the weld bead to the base metal.
- The parameters mainly affects the welding current.
- If the current is very low, it is not sufficient to heat the metal all over the place.
- The wrong design of the weld also causes defects.



#### 2. Lack of root penetration.

- Lack of fusion is a weld bead in which fusion has not occurred throughout the cross section of joint due to improper penetration of the joint.

- Incomplete penetration forms channels and crevices in the root of the weld which can cause serious in pipes because corrosive substances can settle in those areas.

- This defect occurs due to too small root gap, too large size electrode, high travel speed and incorrect use of electrode.

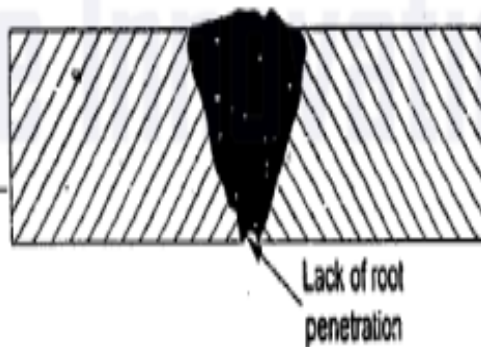

### 3. Cracks:

- Fracture - type interruptions are either in weld or base metal adjacent to weld. It is a serious defect because it is a discontinuity in the metal that significantly reduces strength.

- It is due to embrittlement or low ductility of weld and base metal combined with high restraint during contraction. In general, this defect must be repaired.

• The cracks are mainly classified into the following two types:

1. Hot cracking
2. Cold cracking.

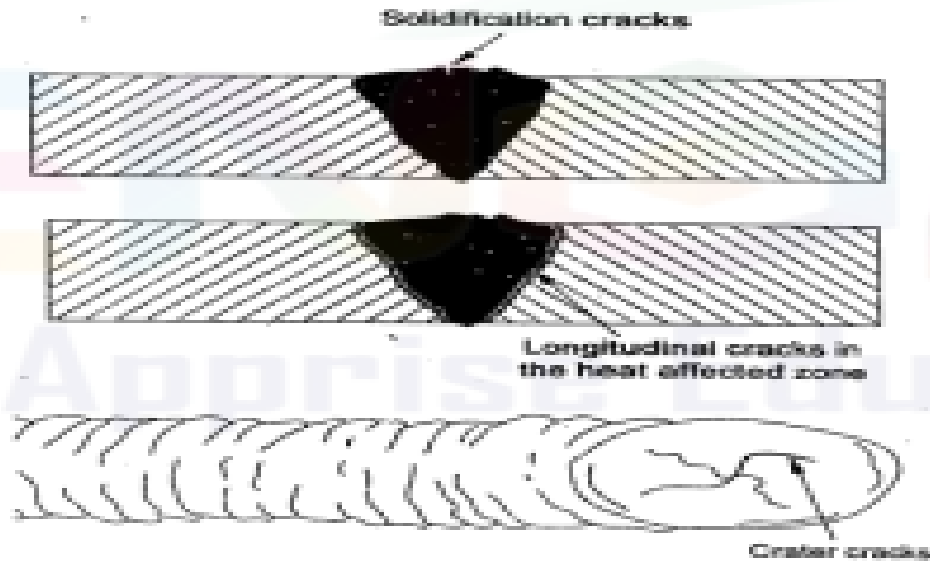

• Figure shows different types of cracks in the weldment. Hot cracking also known as solidification cracking can occur with all metals and happens in the fusion zone of a weld.

• To diminish the probability of this type of cracking, excess material restraint should be avoided and a proper filler material should be utilized.

• A heat-affected zone (HAZ) is a crack that forms a short distance away from the fusion line.

• It occurs in low alloy and high alloy steel.

- The exact causes of this type of crack are not completely understood but the dissolved hydrogen must be present.

- Crater cracks occur in the crater when the welding arc is terminated prematurely.

- Crater cracks are normally shallow, hot cracks usually forming single or star cracks.

- These cracks usually start at a crater pipe and extend longitudinal in the crater.

- Hot cracking occurs at high temperature and cold cracking occurs at room temperature.

- The main causes of crack formation are:

1. Arc speed
2. Ductility
3. Solidification rate.
4. Temperature.

- Residual stresses can reduce the strength of the base material and it can lead to catastrophic failure through cold cracking.

- Cold cracking is limited to steels and it is associated with the formation of martensite as the weld cools.

- The cracking occurs in the heat-affected zone of the base material.

## 4. Cavity:

• There are two cavity type defects that may present in the weldment.

(i) Porosity

(ii) Shrinkage voids.

## Porosity:

• It is small voids in weld metal formed by gases entrapped during solidification as shown in figure.

• It is caused by inclusion of atmospheric gases, sulphur in weld metal or surface porosity.

• The gases are: oxygen, nitrogen and hydrogen.

• The parameters which are causing porosity are

1. Arc speed
2. Coating of the electrode
3. Incorrect welding technique
4. Base metal composition.

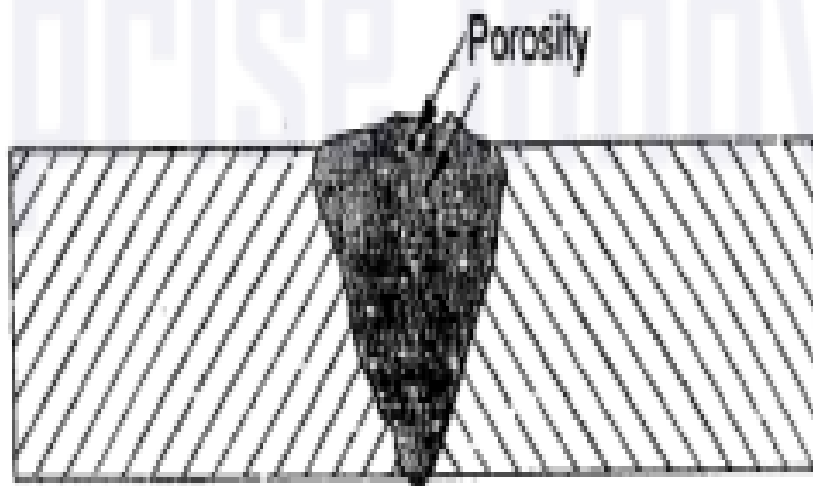

- The Sources of hydrogen formed on the weld pool are electrode coating. Then oxygen becomes as oxide in the pool. Nitrogen enters in the form of atmospheric nitrogen.

### (ii) Shrinkage voids:

- Cavities are formed by shrinkage during solidification.

### 5. Undercut:

- Undercut is a groove gets formed in the parent metal along the sides of the weld as shown in figure. The main causes of the undercut are.

1. High current.
2. Arc length.
3. Electrode diameter.
4. Inclination of electrode.

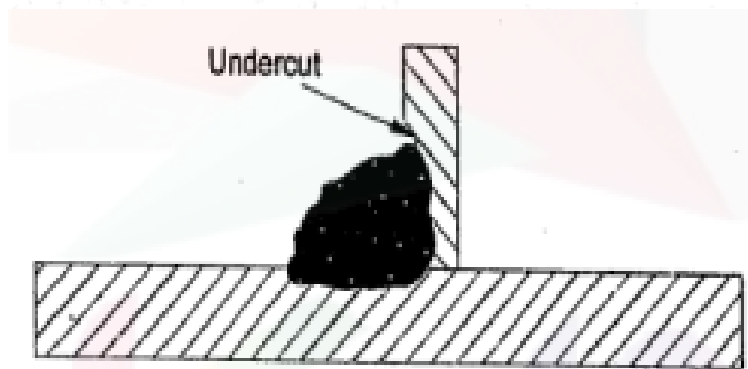

### 6. Distortion:

- Distortion is defined as the change in shape and difference between positions of two plates during the welding.

- The base metal under the arc melts and already welded base metal starts cooling it will create a temperature difference in the weld and will cause distortion.

1150011111.

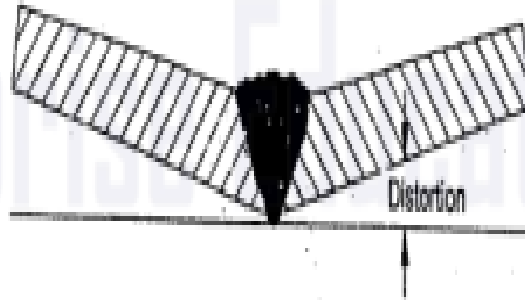

The factors which are causing distortion are:

1. Arc speed,
2. No of passes,
3. stresses in plates.
4. Joint type
5. Order of welding.

### 7. Slag inclusion :

- During solidification of weld, any foreign materials present in the molten metal will not float.
- It will be trapped inside the metal; so, it will be lower the strength of the joint.
- Most common form is slag inclusions generated during arc welding processes that use flux instead of floating to top of weld pool and globules of slag become encased during solidification.

• Other forms are metallic oxides that form during welding of certain metals such as aluminium which normally has a surface coating of  $Al_2O_3$ .

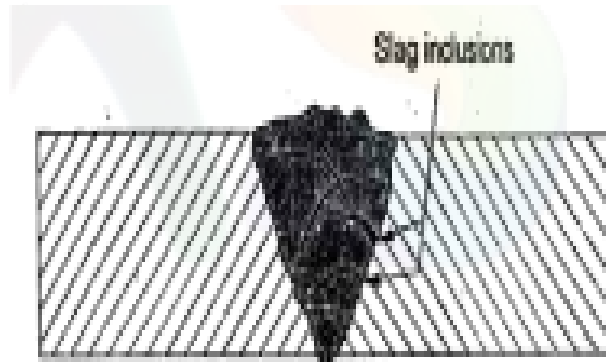

### 8. Lamellar Tearing:

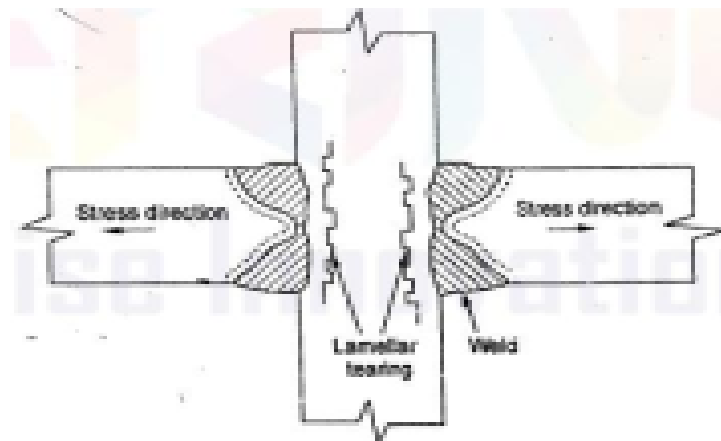

It is mainly a problem with low quality steels. It occurs in plate that has a low ductility in the through thickness direction which is caused by non-metallic inclusions such as sulphides and oxides that have been elongated during rolling process. These inclusions mean that the plate cannot tolerate the contraction stresses in the



Short transverse direction. It is seen in large structures. Lamellar tearing can occur in both fillet and butt welds but the most vulnerable joints are T and corner joints where the fusion boundary is parallel to the rolling plane.

### 9. Overlap:

Overlap is the protrusion of the weld metal beyond the weld toe or weld root. It may occur because of fusion problem.

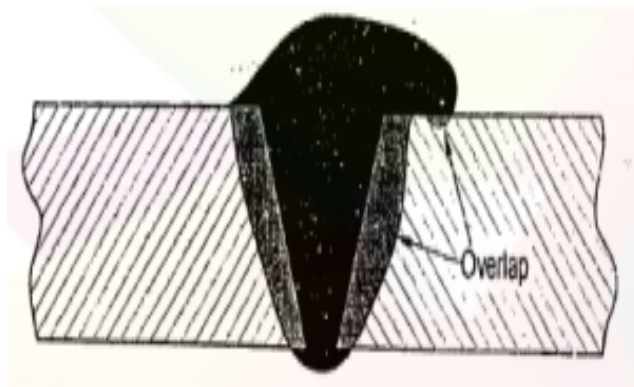

The parameters which are causing overlap are:

1. Arc length,
2. Arc speed
3. Joint type
4. Current.

### 10. Spatter:

Spatter is small droplets of electrode material which have been ejected from the arc which may or may not have fused to the parent plate.

• The main causes of spatter are high welding current, excessive arc length, damp electrodes, arc blow, incorrect electrode angle, incorrect polarity and poor gas shielding.

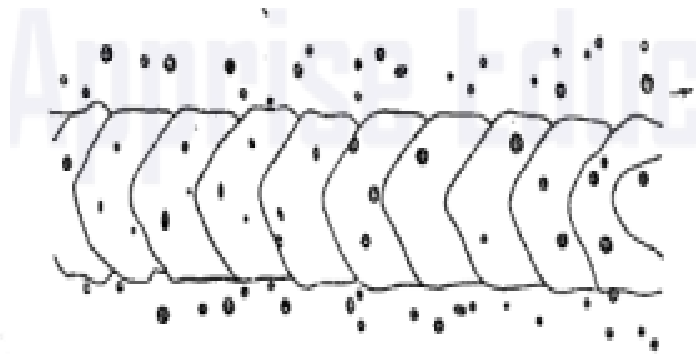

### Radiographic Inspection:

• Radiography (X-ray) is an NDT method used to inspect material and components using the concept of differential absorption of penetrating radiation.

• Each specimen under evaluation will have differences in density, thickness, shapes, sizes or absorption characteristics.

• Thus, the different amount of radiation is absorbed. The unabsorbed radiation that passes through the part is recorded on film, fluorescent screens or other radiation monitors.

• Indications of internal and external conditions will appear as variants of black/white/gray contrasts on exposed film or variants of colour on fluorescent screens.

- This technique is suitable for the detection of internal defects in ferrous and nonferrous metals, and other materials.

- Radiography has an advantage over some of the other processes in that the radiography provides a permanent reference for the internal soundness of the object that is radiographed.

- X-rays and gamma rays are used in the radiographic test.

- The X-ray emitted from a source has an ability to penetrate metals as a function of the accelerating voltage in the X-ray emitting tube.

- If a void present in the object being radiographed, more X-rays will pass in that area and film under the part in turn will have more exposure than non-void areas.

- Hence, the voids show as darkened areas on a clear background as shown in figure.

- This test is used to detect the internal defects such as cracks, porosity, blow holes, inclusions.

- In this test, a film or a photographic plate is placed behind and in contact with weld surface.

- The portion is exposed to a beam of X-rays. X-rays are produced in an X-rays tube.

- During exposure, X-rays penetrate through the weldment and then affect the X-ray film.

- After developing the film, a radiograph is obtained. This radiograph shows the nature of defect.

- Blow holes, cracks, cavity and porosity appear higher than the surrounding area.

- This is a quicker method but the cost of test is high.

- The radiograph is used as a permanent record.

- The radiation may affect human beings.

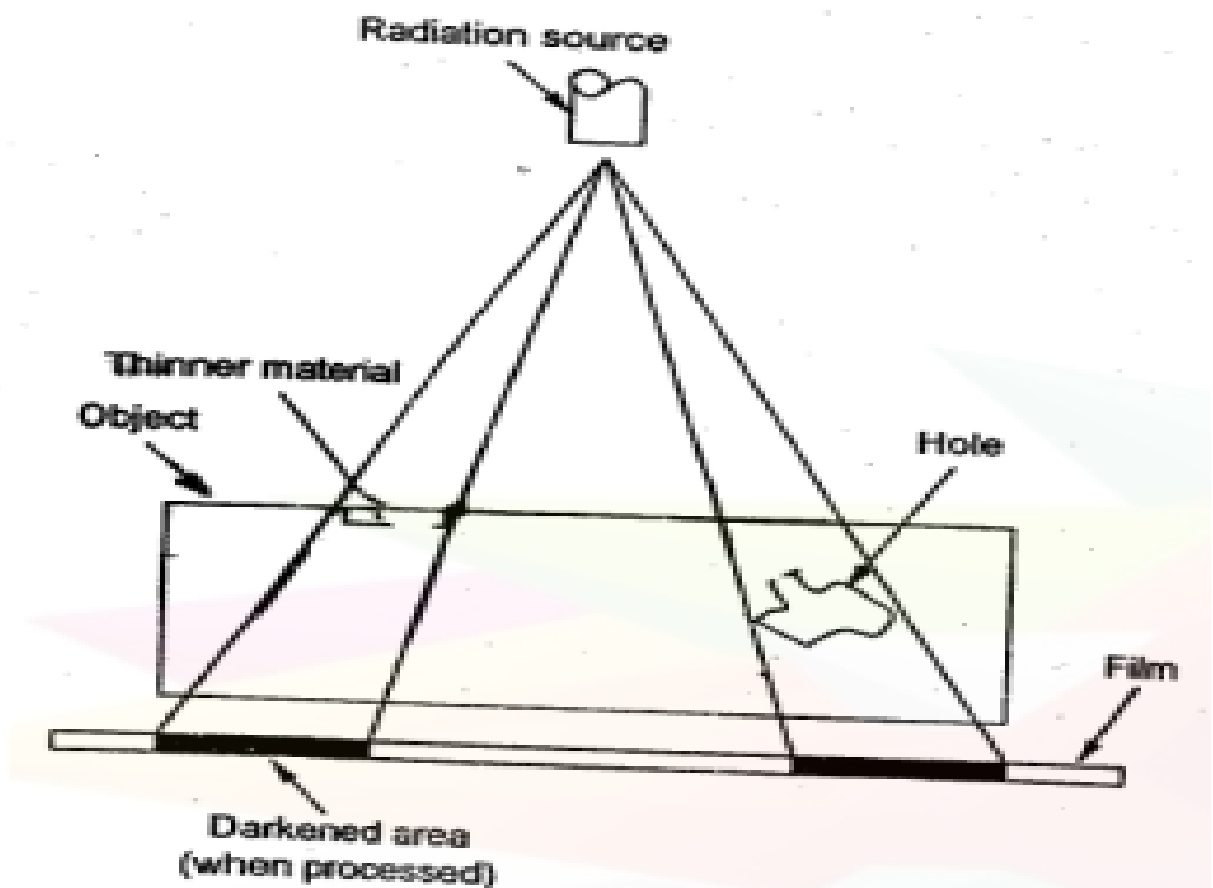

## Advantages :

1. It can be used to inspect virtually all materials.
2. Detects both surface and subsurface defects can be identified.
3. It has the ability to inspect complex shapes and multi-layered structures without disassembly.
4. Minimum part preparation is required.
5. Information is presented pictorially.
6. A permanent record is provided which may be viewed at a time and place distant from the test.
7. It can be used for inspecting hidden areas. (direct access to surface is not required).

## Limitations :

1. Extensive operator training and skill are required.
2. Access to both sides of the structure is usually required.
3. Orientation of the radiation beam to non-volumetric defects is critical.

4. Field inspection of thick section can be time-consuming.

5. Relatively expensive equipment investment is required.

6. Possible radiation hazard for personal occurs.

7. Depth of discontinuity is not indicated.

8. Film processing and viewing facilities are necessary as is an exposure compound.

9. It is not suitable for automation unless the system incorporates fluoroscopy with an image intensifier or other electronic aids.

### Ultrasonic Inspection :

- This method is used to find internal defects by using ultrasonic sound waves.

- Very minute defects such as cracks, porosity, blowholes etc. can be accurately detected in castings.

- Sound waves can pass through solids without any absorption.

- It can also be reflected from a surface

- Hence, ultrasonic waves are used in this test.

- These ultrasonic waves are produced by a transducer.

- The transducer can change the high frequency electrical energy into ultrasonic sound waves. It is called transmitter which can also change the ultrasonic sound waves into electrical energy.

### Principle:

- High frequency sound waves are sent into a material by the use of a transducer.
- The sound waves travel through the material and they are received by the same transducer or a second transducer.
- The amount of energy transmitted or received and time to receive the energy is analyzed to determine the presence of flaws.
- Changes in material thickness and properties can also be measured.

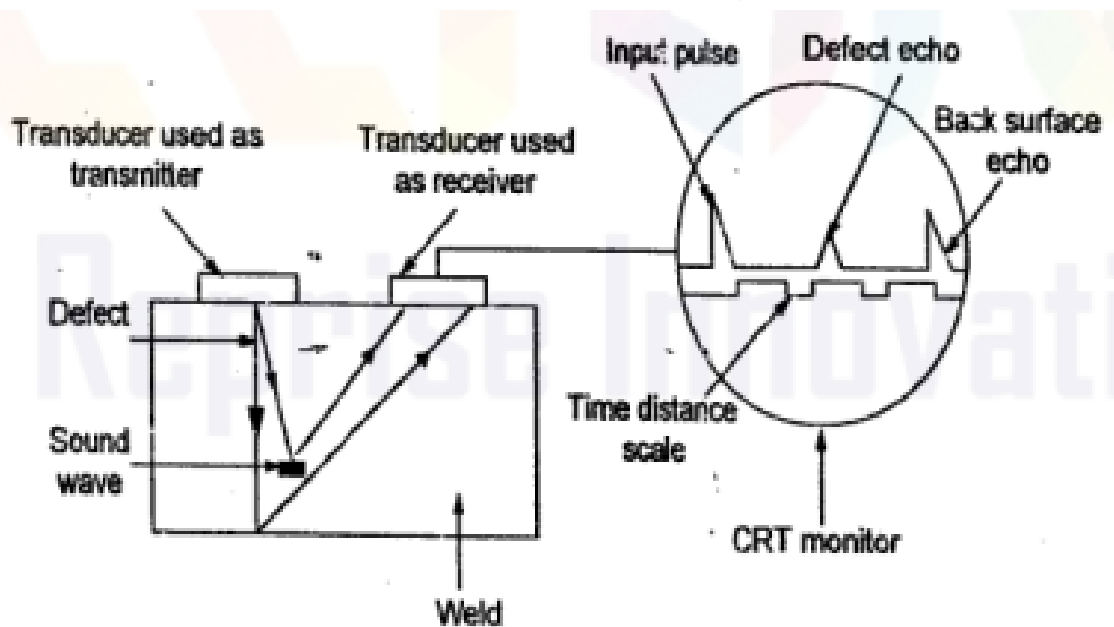

- If the work is defect, the wave will strike the bottom of the work and return to the receiver.

- The striking of waves at the bottom surface and top surface are indicated in the form of Pip (echo) in CRT as 1 and 3 as shown in figure.

- If there is any defect in between top and bottom surfaces, the wave is reflected back from that spot and it is indicated as pip in CRT as 2.

### Ultra Sonic inspection technique:

- Two basic ultrasonic inspection techniques are employed such as pulse - echo and through - transmission

- Pulse - Echo inspection:

- This process uses a transducer to both transmit and receive the ultrasonic pulse as shown in figure (a).



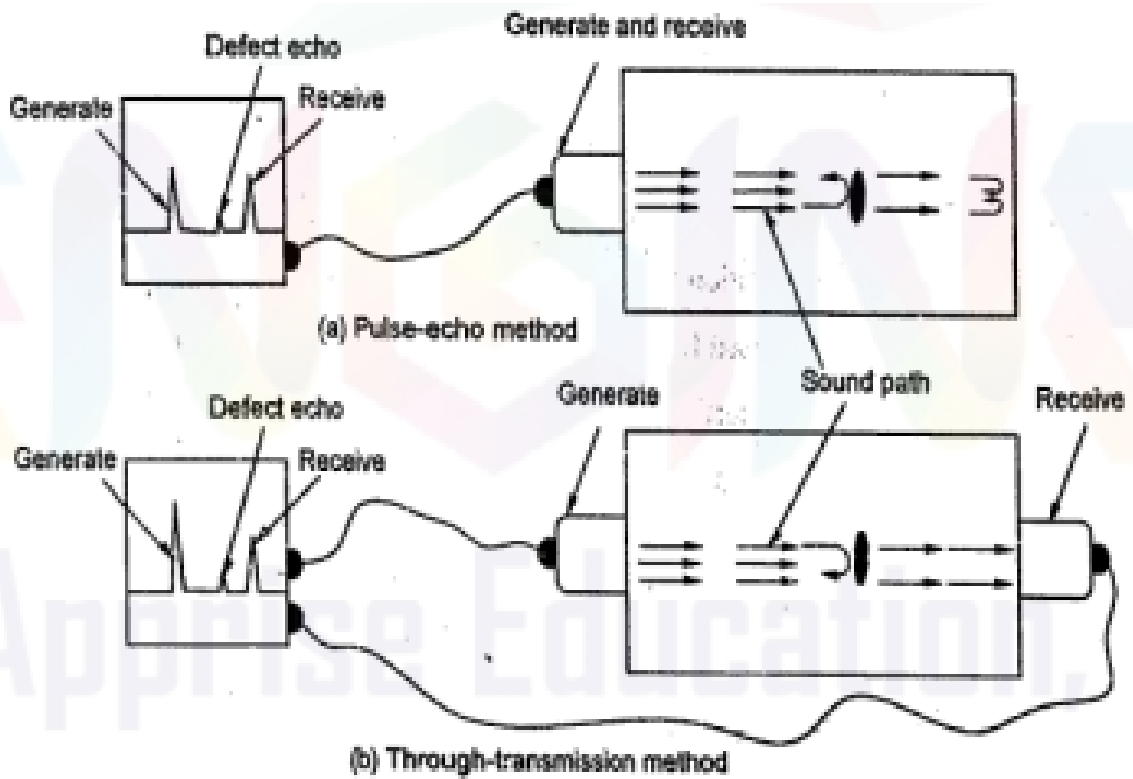

• The received ultrasonic pulses are separated by the time. It takes the sound to reach the different surfaces from which it is reflected.

• The size (amplitude) of a reflection is related to the size of the reflecting surface.

• The pulse-echo ultrasonic response pattern is analyzed on the basis of signal amplitude and separation.

• Through-transmission inspection.

• This inspection employs two transducers

• Among them, one is to generate and the second one is to receive the ultrasound as shown in figure (b)

• A defect in the sound path between two transducers will interrupt the sound transmission. The magnitude (the change in the sound pulse amplitude) of the interruption is used to evaluate test results.

• Through transmission inspection is less sensitive to small defects than pulse-echo inspection.

• Ultrasonic inspection is used to detect surface and subsurface discontinuities such as cracks, shrinkage, cavities, burrs, flakes, pores, delaminations and porosity.

### Steps used in the testing:

The following steps should be applied during the inspection.

(a) The couplant steps should be applied during the inspection.

(b) For the circular test specimen, the prop will be placed in the corresponding space in the supporting fixture tool.

Enough couplant should be used between probe and coil.

(c) for the flat specimen, no tool is needed and couplant is only applied between inspected surface and probe.

(d) special ~~trans~~ should be paid on the location where the possible cracks exist.

(e) A discontinuity like a crack produces a peak on the screen.

(f) Attention should also be given to the movement of the possible peak caused by the cracks on the specimen.

### Advantages:

1. It is a fast and reliable process.
2. Minimum part preparation is required.
3. This method can be used for much more than just flaw direction.
4. This is sensitive to both surfaces and surface discontinuities.
5. The depth of penetration for flaw direction of measurement is superior to other NDT methods.

## Limitations:

1. Surface must be accessible to transducer and couplant so that ultrasound can be transmitted.
2. Surface finish and roughness can interfere with inspection.
3. Thin parts may be difficult to inspect.
4. Skill and training are more extensive than with some other methods.
5. It normally requires a coupling medium to provide the transfer of sound energy into the test specimen.
6. Materials that are rough, irregular in shape, very small, exceptionally thin or not homogeneous are difficult to inspect.
7. Linear defects oriented parallel to the sound beam may be undetected.
8. Reference standards are required for both equipment calibration and the characterization of flaws.